

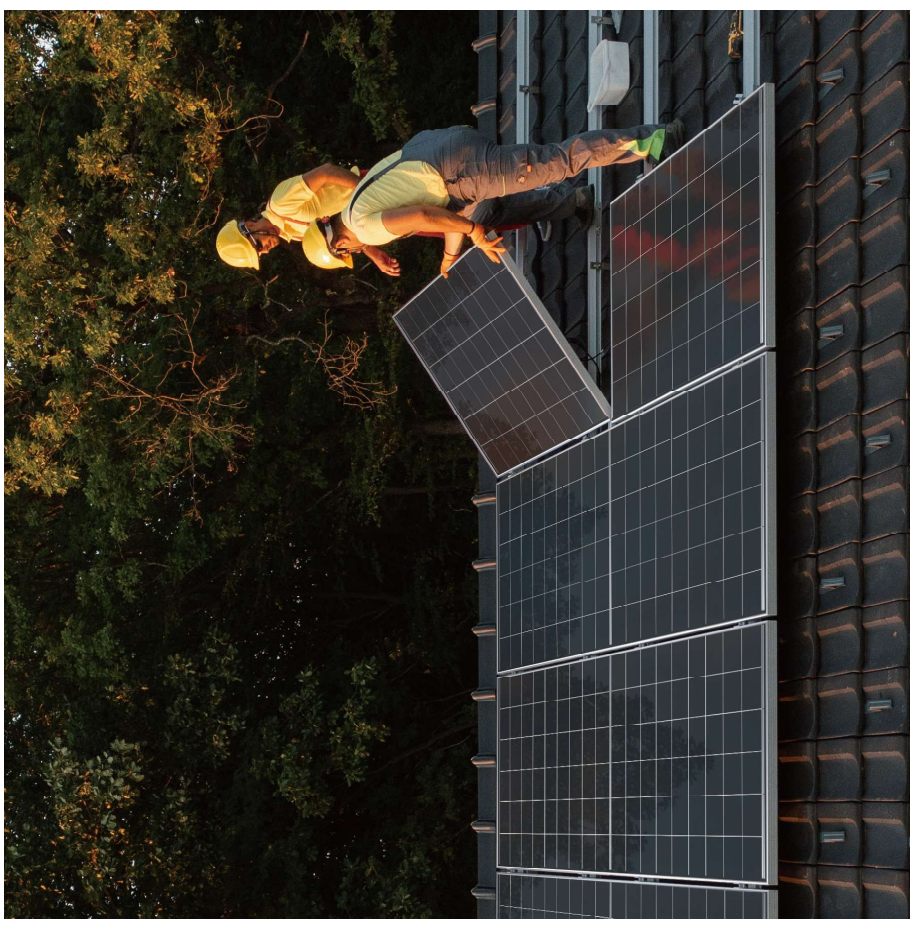

AIKO PV Module Installation Manual

Single Glass Module



Website: www.aikosolar.com
Email: marketing@aikosolar.com

* Product data updated by the end of July, 2023. AIKO Energy reserves the right to revise the manual without prior notice.

CONTENTS

AIKO PV Module Installation Manual Single Glass Module

AIKO reserves the right to change this Manual without prior notice. Please check the latest version of the Installation Manual in the official website of AIKO. Website: www.aikosolar.com

Single Glass Modules Installation Manual, version 2.0, August 2023



Applicable module models

AIKO-Axxx-MAH54Mw	AIKO-Axxx-MAH72Mw	Module structure
AIKO-Axxx-MAH54Mb	AIKO-Axxx-MAH72Mb	Single Glass

Table 1: Applicable modules models



Important safety instructions

- This Installation Manual provides information regarding the installation and safe use of PV modules (hereinafter referred to as "modules") produced by AIKO Digital Energy Technology Co., Ltd. (hereinafter referred to as "AIKO"). Installation and day-to-day maintenance of modules shall be in accordance with all safety precautions specified in this Manual and local laws.
- Installing module systems requires specialized skills and knowledge, and modules shall be installed and maintained by qualified persons. The installers shall be familiar with mechanical and electrical requirements of the system. Please keep this Manual for future maintenance or treatment.

01 Overview P01

02 Laws and acts P01

03 General information P02

- 3.1 Module identification
- 3.2 Wiring method
- 3.3 General safety
- 3.4 Electrical safety
- 3.5 Handling safety
- 3.6 Fire safety

- 6.2.1 Mounting pressure clamps
- 6.2.2 Single glass modules clamping diagram and corresponding loads
- 6.2.3 Bolts Mounting
- 6.2.4 Single glass modules bolt mounting diagram and corresponding loads
- 6.2.5 Single-axis tracking system installation

04 Storage and transportation instructions P07

- 4.1 Considerations for module unloading
- 4.2 Considerations for module transportation
- 4.3 Considerations for module storage

07 Electrical installation P17

- 7.1 Electrical performance
- 7.2 Cables and Connections
- 7.3 Connector

08 Grounding P20

09 Maintenance of PV modules P21

- 9.1 Cleaning
- 9.2 Visual checks of the modules
- 9.3 Checks of connectors and cables
- 9.4 AIKO Technical Support

05 Installation conditions P09

- 5.1 Location and working environment
- 5.2 Tilt angle selection

06 Mechanical installation P11

- 6.1 General requirements
- 6.2 Mechanical installation of single glass modules

3.2 Wiring method

The junction box of AIKO modules is located in the middle position. Please refer to the table below for how to connect AIKO modules in series.





Position of junction box		Module mounting type		Connection diagram	
	Mounting on the long side, single row		Horizontally adjacent modules are directly connected at the shortest distance or, if the wire is too long, by placing the wire into the secondary beam.		
	Mounting on the long side, double rows		<ol style="list-style-type: none"> Horizontally adjacent modules are directly connected at the shortest distance or, if the wire is too long, by placing the wire into the secondary beam; Connections between adjacent rows of modules shall be designed and installed by considering the opposite polarity on the same side as shown below. Adjacent modules are side connected by routing the wire through a duct instead of using an uncovered wire. 		
	Mounting on the short side, single row		In vertical installation, connections between vertically adjacent modules are de-signed and installed with opposite polarities between adjacent modules as shown and the extension line can be placed into the secondary beam.		
	Mounting on the short side, multiple rows		<ol style="list-style-type: none"> Vertically adjacent modules as shown below are connected at the shortest distance; Connections between adjacent columns of modules shall be designed and installed by considering the opposite polarity on the same side as shown below. Adjacent modules may be side connected by placing the wire into the secondary beam. 		

Table 2: Connection diagram as per mounting type

Packing List Packing list contain the information of module type, product serial number, package weight, package dimension as well as cells color classification. To ensure consistency of the overall color of system when customer use the modules, the box of modules is packaged base on same color of cells and marking the with S1, S2, S3, on the packing list. Following as an sample:

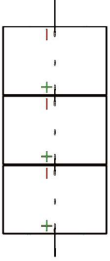
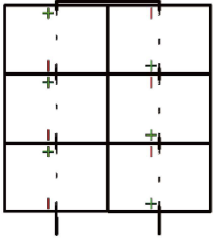
AIKO Packaging List		Module Power	450 W
Pallet No.	A223711001	Qty	36 PCS
Product No.	300100000125-450-	Color Code	S2
Module Type	AIKO-A450-MAH54Mb	Bin Code	MABR035
Product Description	450/A12BB/1722*1134*30mm/PV-ZH01C-525A, 2550045, PV-ZH202B, 350mm/A 223711001		
N.W.	738.0 KG	G.W.	788.5 KG
S/N:2D	 Remark:		
		Package Size 1765*1140*1275mm	
		Made in China	
NO.	Serial Number	NO.	Serial Number
1	Z012306E001000001	2	Z012306E001000001
4	Z012306E001000001	5	Z012306E001000001
7	Z012306E001000001	8	Z012306E001000001
10	Z012306E001000001	11	Z012306E001000001
13	Z012306E001000001	14	Z012306E001000001
16	Z012306E001000001	17	Z012306E001000001
19	Z012306E001000001	20	Z012306E001000001
22	Z012306E001000001	23	Z012306E001000001
25	Z012306E001000001	26	Z012306E001000001
28	Z012306E001000001	29	Z012306E001000001
31	Z012306E001000001	32	Z012306E001000001
34	Z012306E001000001	35	Z012306E001000001
		36	Z012306E001000001

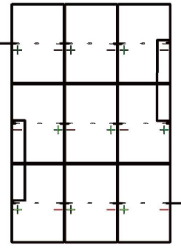
3.3 General safety

AIKO modules are designed certified according to IEC-61215 and IEC-61730. Modules are designed with safety class II and fire class rating C.

- Before to handle and install AIKO PV module, read carefully and understand this Installation Manual. If you need any explanation, contact AIKO (aikosolar.com)
- Always use appropriate protections such as insulated tools, safety helmets, insulating gloves, safety belts and safety insulating shoes when handling the module whether it is or not connected to the system. Please use appropriate electrical safety tools when you need to install, ground, connect, clean or handle the module.
- PV modules generate DC electrical energy when exposed to sunlight or other light source. Improper contact with live parts of the module (e.g. connectors) can result in burns, sparks, and lethal shock
- Observed local laws and regulations for module installation and obtain a building license or other qualifications where necessary.
- Modules shall be installed by qualified persons who have specialized skills and knowledge and are familiar with the mechanical and electrical requirements of the system. Potentially harmful risks during installation, including electrical shock, shall be identified in advance.
- Rooftop systems can only be installed on the roofs which have passed the evaluation of construction experts with formal, full structural analysis results, where necessary.
- Observed the safety regulations for all mounting components. For example, wires and cables, connectors, inverters and batteries.
- Artificially concentrated sunlight shall not be directed onto the module



3.5 Handling safety

- Standing, stepping, sitting, walking or jumping on the module package or module is prohibited.



- Do not place heavy objects on the module.

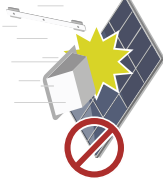

- Do not connect the positive and negative cables of the same PV module together
- Do not open the packing box before the modules arrive at the location, keep the packing box in a ventilated, dry environment.
- During the transportation, please refers to 4.0 Storage and Transportation Instructions. Any inappropriate handling and storage can result in breakage of glass or loss of electrical property, and consequently loss the use value of modules.
- Take careful when install the modules, In any case, it is forbidden to lift the module by lifting the junction box or cable. At least two or more than two operators must hold the edge of the module with both hands.
- Do not try to dismantle the module or remove any nameplates or components of modules.
- Do not paint or apply other adhesives to modules
- Do not damage or scratch backsheet or glass of modules
- Do not drill holes on the frame of module, which may reduce frame loading capacity and lead to frame corrosion and invalidation of the limited warranty provided for customers.
- Do not scratch anodized coating of aluminum alloy frame except for grounding connection. Scratch may lead to frame corrosion and reduce frame loading capacity and long-term reliability.
- Do not repair or modify the module on your own.

3.4 Electrical safety

Please strictly follow the electrical safety precautions below to avoid any form of electrical safety accident.

- Modules can generate DC voltage>30V, current>10A under standard temperature condition (STC), take care to avoid direct contact. Always wear safety helmet, insulated gloves, insulated rubber shoes, and other protective measures during installation.
- Do not drill holes in the frame, which may cause module insulation failure.
- Do not make electrical connection by means other than connectors.
- Broken modules have the risk of electric shock and fire that must be replaced immediately.
- Module should be installed when it is electrically safe to do so.
- Avoid touching modules as the surface and frame of the modules may hot and there is a risk of burns or electric shock. The output voltage connected in series of the modules must not exceed the maximum withstand voltage value.
- Do not connect or disconnect the module when there is a current leakage of module or when there is an external current present. Please disconnect the faulty modules with safety protection.

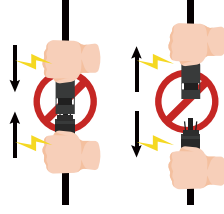

3.6 Fire safety

- Please refer to local laws and regulations before installing modules and abide by requirements on building fire protection.
- The roof should be coated by a layer of fireproof materials with suitable fire protection rating for roofing installation and make sure that the back sheet and the mounting surface are fully ventilated.
- Different roof structures and installation modes will affect fireproof performance of buildings. Improper installation may lead to the risk of fire.
- To guarantee roof fire rating, the distance between module frame and roof surface must be greater than 10 cm
- Please use proper module accessories such as fuses, circuit breakers and ground connectors according to local laws and regulations.
- Please do not apply modules in where exposed inflammable gases are nearby.

04

Storage and transportation instructions

4.1 Considerations for module unloading

Upon arrival of the modules, please check the packaging box is in good condition, and check whether the module type and quantity on the outer packaging are consistent with the delivery order, if anything is wrong, please contact AIKO logistics and sales staff immediately.

■ Crane unloading:

When unloading the modules by crane, please choose and use specialized tooling according to the weight and size of the pallet. Please adjust the position of the sling to keep the modules steady.

To ensure the safety of the module, wooden sticks, boards or other fixtures of the same width as the outer packing cases should be used on the upper part of the box to prevent the sling from squeezing the pallet and damaging the modules. Please operate the spreader at a constant speed, when the lifting is close to the ground, place the box gently in a relatively flat ground.

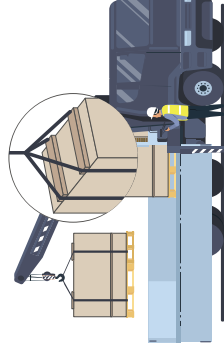

Do not unload modules under the weather conditions of wind more than 6 class (in Beaufort scale)

■ Forklift unloading:

The loading dock should be as the same height as the underside of the carrier.

Keep the straight line speed of forklift within 5km/h and the turning speed within 3km/h. Please avoid sudden stop and rapid start.

If the packing box blocks the sight of the forklift driver, it is recommended to drive backwards during the fork-lifting, and arrange for special supervision and command to prevent bumping into people or items causing personal injury or damage to the modules.

4.2 Considerations for module transportation

- When using forklift to transport modules, please ensure that the fork length meets the requirements to avoid module tilting due to uneven force.
- When opening the packing box, please place the modules to be unpacked at a distance of 20-30cm from the wall or another torr of modules, and then remove the torr. After removing the cable tie of the fixed modules, slowly lean the modules against the wall or another torr of modules to prevent them from falling.
- Please handle the installation modules gently during transportation, Do not lift the modules by pulling the junction box or cables under any circumstances. Two or more people must hold the edges of the modules with both hands.

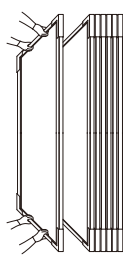

4.3 Considerations for module storage

- Please store the packing box of modules in a clean, dry place with relative humidity below 85%. The storage temperature should be between -20 °C and 50 °C. When storing modules for a long time, do not place the two boxes of modules on top of each other.
- In any circumstances, keep the junction box and cables of the modules clean and dry.
- Store modules in a ventilated, rainproof, dry place, if placed outdoor, please fully cover the modules and pallets with a rain protection and take moisture-proof measures on pallets and cartons to prevent collapse and moisture ingress.
- For the storage of unpacked modules, please stack the modules flat on the empty torr. The first module should be placed with the glass side up, and the following ones placed with the glass side down. (A maximum of 25 pieces of modules for 54 types and 20 pieces of modules for 72 types can be stacked together).
- For long-term storage, do not remove the original package and keep the wrapping film and carton box in a good condition. It's recommended to place modules in a standard warehouse for long-term storage and conduct regular inspections. Once there is an abnormal tilt, please take enforcement measures in time.

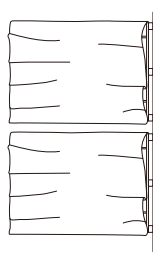

05 Installation conditions

5.1 Location and working environment

- Modules are recommended to be installed in the working environment with the temperature of -20°C–50°C environment. The extreme working ambient temperature is -40 °C–85 °C and a humidity less than 85%RH.
- Modules are designed to operate up to 2000 m above sea level.
- Do not install modules in locations where there is a risk of flooding, and do not install or place modules near open flame or flammable materials
- Modules can be installed at a distance of 50m from the seashore. In the case when the modules are installed within 50m to 500m distance from the seashore, the frame and related components need to be treated with anti-corrosion.
- For rooftop installations, leave a safe working area between the edge of the roof and the external edge of the PV module array.
- For rooftop installations, check the roof loads and make a construction organization plan to meet the applicable standards.
- Modules shall be positioned to receive adequate sunlight and avoid shading the module surfaces in part or in whole (by trees, buildings, etc).

- Modules shall be installed in a well-ventilated position to ensure adequate air circulation on the back and sides of the module and allow immediate dissipation of heat produced during module operation, poor heat dissipation of the modules will decrease the output power and affect the overall power output of modules.

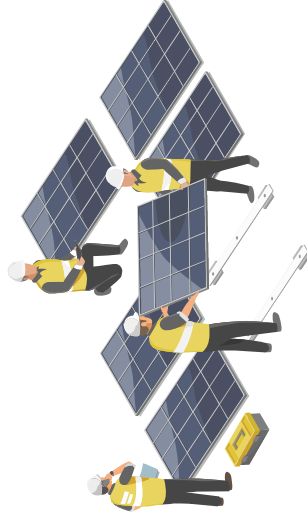

- When modules suffer high wind or snow pressure, supports and fixings shall be designed according to local design standards to keep external loads within the maximum mechanical strength that modules can withstand.

- In areas (e.g. coastal areas, factories, volcanic areas, farmlands) exposed to salt fog, sulfide or ammonia gas, corrosion can occur at the connection between the module and the racking or at the ground connection. Anticorrosive materials (e.g., stainless steel or aluminum materials) must be used in contact with PV modules and the mounting position must be protected against rust.
- After the modules are installed, measures such as grounding must be taken to ensure that the modules are protected against lightning strikes

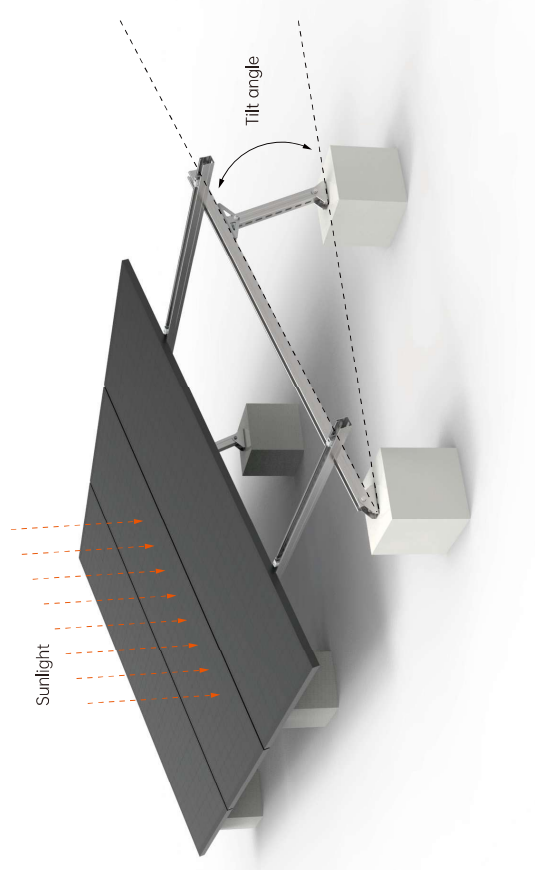

5.2 Tilt angle selection

Tilt angle of PV modules refer to the included angle between module surface and horizontal ground. Different projects shall choose different installation inclination angles according to local conditions.

All modules in the same array shall be of the same orientation and angle. Different orientations and angles will result in different total solar irradiation absorbed by modules, leading to output mismatch and decrease the system operating efficiency.

In order to achieve the maximum annual generating capacity, the optimal orientation and inclination of PV modules in the installed area should be selected. When the surface of the module is perpendicular to sunlight, the output power reach the maximum output value. AIKO recommend the installation angle shall not less than 10 degree. The optimal tilt angle of PV arrays shall be designed by taking into account the multi-year mean monthly irradiance, direct irradiance, scattering irradiance, wind speed and other climate conditions at the location. PV modules should be tilted at an angle to receive the maximal annual irradiance. Angles shall be selected by considering natural conditions such as local wind load, snow load and avoidance of water and dust collection on module surfaces. For details on the optimal tilt angle for installation, refer to consult a reliable local solar system installation company.

06 Mechanical installation

6.1 General requirements

- Make sure that the modules are properly installed and the mounting structure are adequately fastened. Mounting system shall be made from anticorrosive, ultraviolet resistant materials.
- Installation bracket system shall be tested and inspected by the third party testing institution with static mechanical analysis capacity in accordance with local national standards or international standards.
- In regions with heavy snowfall in winter, adjust the height of the mounting system so that the lower edge of the module is not covered by snow. In addition, ensure the lower part of module is not in the shadow of plants, trees.
- For rooftop installations, the minimum gap between the module frame and the roof shall be 10cm which is good for air circulation to achieve better performance of module.
- The minimum mounting distance between two adjacent modules shall be no less than 10 mm.
- Make sure that backsheet of modules will not be in contact with bracket or building structures that can pierce into the inside of the modules, especially when the module surface is imposed by pressure
- Modules can be installed horizontally or vertically. When installing the components, be cautious not to block the drain hole of the frame
- The module loads described herein are test values. According to IEC 61215-2016 installation requirements, when computing the corresponding maximum design load, a safety factor of 1.5 need to be considered in compliance with the local laws or regulations. In additions, project design loads must be based on project location, climate, mounting structure and applicable standards. Design loads are determined by mounting suppliers. Please observe both the local laws and regulations and the instructions of structural engineers.

6.2 Mechanical installation of single glass modules

AlKO single glass modules can be connected to the mounting system using pressure clamps and bolts. Modules must be mounted as recommended and illustrated below. Other mounting configurations may be used provided that consultation is made with, and prior written consent is received from, AlKO Energy. Failure to do so will invalidate our warranty.

6.2.1 Mounting pressure clamps

The module can be mounted by a dedicated clamp, as shown below.

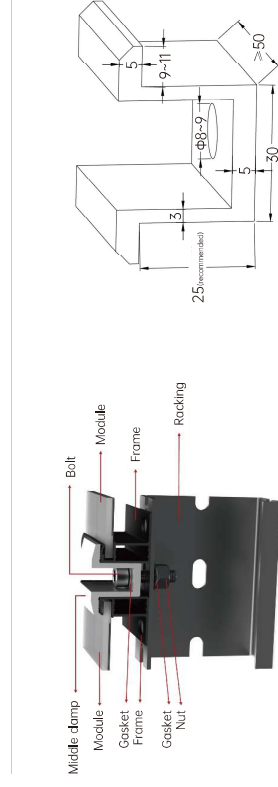
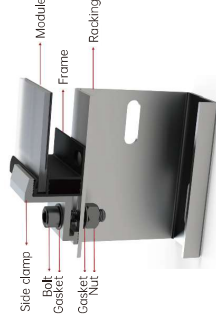

Under no circumstances should the clamp touch the glass or deform the frame. Be sure to avoid shadowing effect from the pressure clamp.

Be sure that pressure clamps will not fail due to deformation or corrosion while the entire module is under load. Pressure clamps > 50 mm in length and >3 mm in thickness are recommended. The overlapped distance between the pressure clamp and the module frame, D, shall be at least 7 mm but no more than 10 mm.

When choosing clamp-mounting, please be sure to use at least four clamps on each module. Depending on the local wind and snow loads, if excessive pressure load is expected, at least six clamps should be required to ensure the module can bear the load (more details, please contact AlKO technical personnel)

The applied value of torque should refer to mechanical design standard and the bolt type customer is using, for example: M8: 16-20 N•m

6.2.2 Single glass modules clamp mounting diagram and corresponding loads

Single glass modules can be installed using pressure clamps. Following are the installation diagram and corresponding loads. Here, L stand for long side of module, W stand for short side of module, dark area stand for the installation area of the clamp, D, D1 and D2 as defined in table 3, 4 and 5. Distance and length are provided in mm, pressure is provided in Pa.

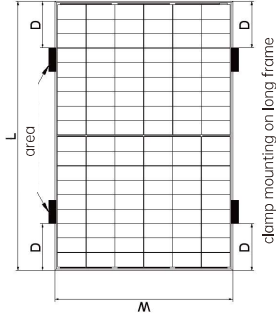

(A) CLAMP MOUNTING - LONG FRAME

Module model	Module size [mm]	Load [Pa]	Installation area D	
			30mm frame	35/40mm frame
AIKO-A***-MAH54Mw AIKO-A***-MAH54Mb	1722*1134	+5400/-2400	295 ≤ D ≤ 395	350 ≤ D ≤ 450
AIKO-A***-MAH72Mw AIKO-A***-MAH72Mb	2278*1134	+5400/-2400	380 ≤ D ≤ 480	400 ≤ D ≤ 500

Table 3: Single glass modules clamp mounting diagram and corresponding loads, long frame (A)

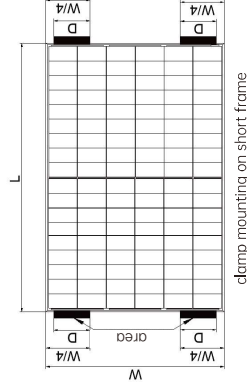

(B) CLAMP MOUNTING - SHORT FRAME

Module model	Module size [mm]	Load [Pa]	Installation area D	
			30mm frame	35/40mm frame
AIKO-A***-MAH54Mw AIKO-A***-MAH54Mb	1722*1134	+1600/-1600	D=W/4-100	D=W/4-50
AIKO-A***-MAH72Mw AIKO-A***-MAH72Mb	2278*1134	/	/	/

Table 4: Single glass modules clamp mounting diagram and corresponding loads, short frame (B)

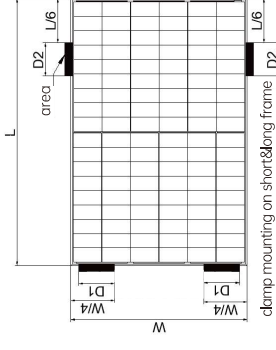

(C) CLAMP MOUNTING - SHORT & LONG FRAME

Module model	Module size [mm]	Load [Pa]	Installation area D	
			30mm frame	35/40mm frame
AIKO-A***-MAH54Mw AIKO-A***-MAH54Mb	1722*1134	+2400/-2400	D1=W/4-100 D2=100	D1=W/4-50 D2=120
AIKO-A***-MAH72Mw AIKO-A***-MAH72Mb	2278*1134	/	/	/

Table 5: Single glass modules clamp mounting diagram and corresponding loads, short & long frame (C)

Note: The above data is based on the static load requirements of IEC61215 standard

6.2.3 Bolts Mounting

Using bolts to secure the module on the bracket through the mounting holes. Modules come standard with 4 or 8 mounting holes, matching M8 bolts, as figure below:

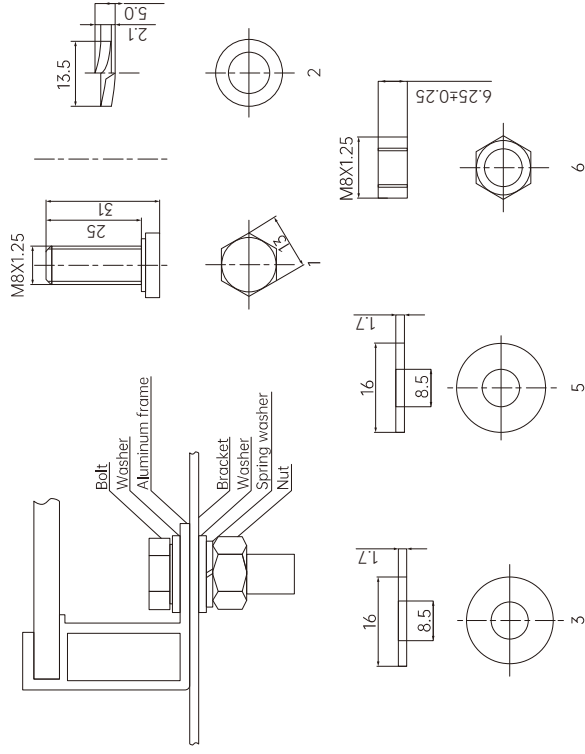

No.	Accessories	Model	Material
1	Bolt	M8*1.25	S35C
2	Spring washer	13.5*2.1	Mn65
3	Washer	16*1.7	Fe
4	Bracket	/	Q235
5	Washer	16*1.7	Fe
6	Nuts	M8*1.25	S35C

It is important to ensure the bolts do not fail due to deformation or corrosion during the overall load of the module. AIKO recommend the thickness of washer should $\geq 1.7\text{mm}$ and use M8 nut and bolt, the tightening torque should be between 16-20 Nm depending on the bolt grade.

6.2.4 Single glass modules bolt mounting diagram and corresponding loads

Single glass modules bolt mounting diagram and corresponding loads as below diagram.

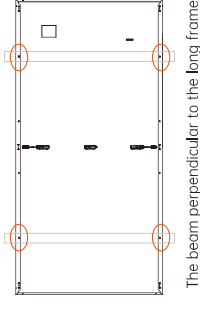

(D) BOLT MOUNTING - TRANSVERSAL

Module model	Module size [mm]	Frame thickness [mm]	Load [Pa]	
			4 inner mounting holes	4 outer mounting holes
AIKO-A***-MAH54Mw AIKO-A***-MAH54Mb	1722*1134	30/35/40	+5400/-2400	+2400/-2400
AIKO-A***-MAH72Mw AIKO-A***-MAH72Mb	2278*1134	30/35/40	/	+5400/-2400

Table 6: Single glass modules bolt mounting diagram and corresponding loads, transversal (D)

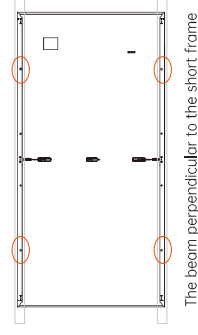

(E) BOLT MOUNTING - LONGITUDINAL

Module model	Module size [mm]	Frame thickness [mm]	Load [Pa]	
			4 inner mounting holes	4 outer mounting holes
AIKO-A***-MAH54Mw AIKO-A***-MAH54Mb	1722*1134	30/35/40	+5400/-2400	+2400/-2400
AIKO-A***-MAH72Mw AIKO-A***-MAH72Mb	2278*1134	30/35/40	/	+5400/-2400

Table 7: Single glass modules bolt mounting diagram and corresponding loads, longitudinal (E)

Note: The above data is based on the static load requirements of IEC61215 standard

6.2.5 Single-axis tracking system installation

AKO 72 type modules come standard with four mounting holes matching M8 bolts (As shown in the figure below, the dotted box is marked that the four M8 bolt mounting holes are all outer four holes); 72 type modules have additional four mounting holes matching M6 bolts (the circle is marked in the figure below) used for matching tracking system product. Using bolt to install the module on the bracket through the mounting hole. Installation details as below:

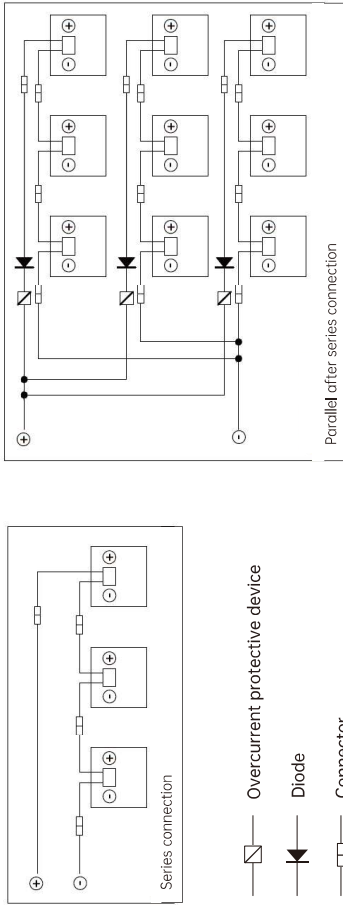
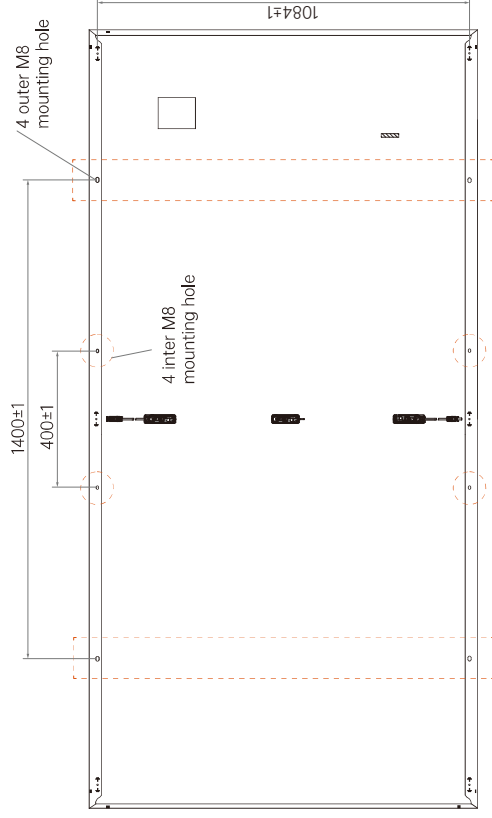

If there has reverse current exceeding the maximum fuse current flowing through the module, use overcurrent protection device with the same specifications to protect the module. If more than two strings are connected in parallel, there must be an overcurrent protection device on each strings of module.

The string voltage must not exceed the maximum voltage that the system can withstand or the maximum input power of the inverter or other electrical devices installed in the system. To ensure this, the open circuit voltage of the array shall be calculated at the minimum expected ambient temperature at that location. The following formula may be used:

$$\text{Maximum system voltage} \approx N \times V_{oc} \times [1 + \beta \times (T_{min} - 25)]$$

07

Electrical installation

7.1 Electrical performance

The electrical performance parameters of AKO modules are detailed in the product specification. Standard test conditions (STC) for PV modules: irradiance 1,000 W/m²; a cell temperature 25 °C; AM1.5. The maximum system voltage of AKO modules is 1,500 V.

When modules are in series connection, the string voltage is sum of every individual module in one string. When modules are in parallel connection, the current is sum of the individual modules as shown below. Modules connected in the same string shall have the same product code and nominal power.

Where:

- N — number of modules connected in series
- V_{oc} — open circuit voltage of each module (refer to product nameplate or specification) [V]
- β — thermal coefficient of open circuit voltage for the module (refer to the specification) [°C⁻¹]
- T_{min} — lowest ambient temperature [°C]

7.2 Cables and Connections

PV module's junction boxes with the IP68 protective level and composed of connected cables and IP68 connectors. The module has a positive and a negative PV wires connected into the junction box and a plug-and-play connector connected at the other end. Using the positive connector of the module to connect the negative connector of the adjacent module connects the two modules in series.

Use specialized solar wires and appropriate connectors according to local electrical and installation standards, codes and regulations at the location, and ensure that the electrical and mechanical properties of the cables are good. AKO modules use specialized PV cables which have a cross sectional area of 4 mm² and are ultraviolet resistant. AKO recommends that all cables are run in appropriate conduits and sited away from areas prone to water collection.

AKO recommend use standard PV copper wires with a cross-section area of 4 mm², temperature-resistant at a minimum of 90 °C, and with UV resistant. The minimum bending radius of the cable is 43mm.

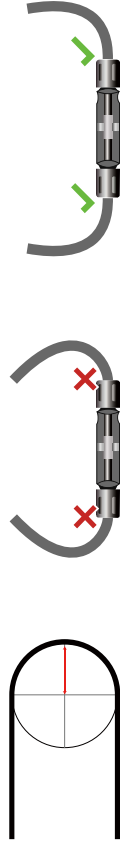

7.3 Connector

Take care to keep the connectors dry and clean. Make sure that the connector nuts are tightened before making any connection. Do not connect while the connectors are wet or otherwise abnormal. As connectors provide IP68 protection only when the positive and negative poles are fully mated, please connect modules as soon as possible after installation or take proper steps to prevent water vapor and dust from coming into the connector.

Avoid exposing the connector to direct sunlight and water. Avoid exposing the connector directly to ground surface or roof.

Make sure that all electrical connections are secure. Incorrect connection can result in electrical arcing and shocks.

Do not mate different models of connectors together.



08 Grounding

Modules are designed with an anodized anticorrosive aluminum alloy frame as a rigid support. Module frames must be grounded to ensure safe use and protect the module against lightning and electrostatic damage. Grounding must be made with the grounding device in full contact with the interior of the aluminum alloy and penetrating the oxide film on the frame surface.

Grounding devices include grounding screws, flat washers, puncture gaskets and grounding wires. All these items shall be constructed of stainless steel except grounding wires. Grounding wires shall be copper wires. Grounding conductors shall be connected to the ground through an appropriate grounding electrode. Third-party grounding devices meeting local electrical installation standards at the location may be used for grounding AKO modules. Grounding device shall be installed according to the operation manual provided by the manufacturer.

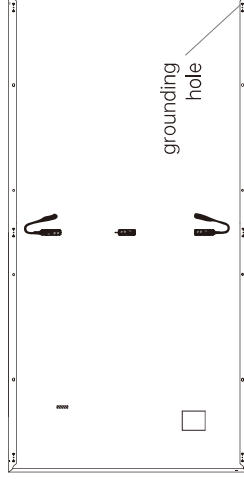

Following is the recommended grounding method:

There are $\phi 4.2$ mm grounding holes on surface C of the module frame. Use a separate grounding wire and accessories to connect the aluminum alloy frame of PV modules and connect the grounding wire to the ground. We recommend using M4×12 mm grounding bolts accompanied by M4 nuts, star washers and flat washers.

We recommend torquing grounding bolts to 3~7 Nm and using 4 mm2 copper wires as grounding wires.

Unused module mounting holes on the frame may also be used for grounding purposes.

Connection mode: the star washer, flat washer, and ground wire are placed in sequence, threaded through the ground hole using screws, and tightened to secure the adjacent modules.

Components

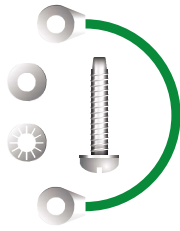

Sketch map

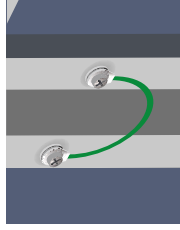

We recommend using the following method to ground correctly, as shown in the figure.

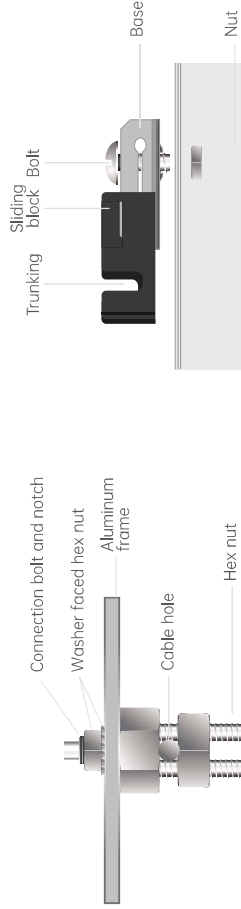

We recommend cleaning the glass surface of the module with a clear water-wetted sponge. Do not clean modules with a detergent containing acid or alkali. Do not clean modules with rough surface tools.

We recommend cleaning modules in the early morning or late afternoon or other periods of time when the light is weak and the module temperature is comparatively lower.

Method A: High pressure water cleaning

Water quality requirement

- PH:6-8
- Water hardness - calcium carbonate concentration: <600mg/L
- Recommended use of soft water cleaning
- Recommended maximum water pressure is 4MPa (40bar)

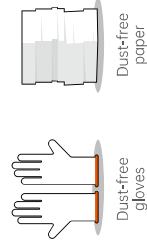
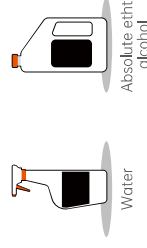

Method B: Compressed air cleaning

- Air pressure cleaning is recommended when cleaning soft stains (like dust) on modules.

Method C: Wet test cleaning

- If there is too much stain on the surface of the module, it's recommended to carefully use an insulating brush, sponge or other soft cleaning tool.
- Ensure that any brushes or agitating tools are made of insulating material to minimize the risk of electric shock and that they do not scratch the glass or aluminum frame.
- For oil stains, it's recommended to use an environmentally friendly cleaner.

Method D: Robot cleaning

- If there is too much stain on the surface of the module, it's recommended to carefully use an insulating brush, sponge or other soft cleaning tool.
- Ensure that any brushes or agitating tools are made of insulating material to minimize the risk of electric shock and that they do not scratch the glass or aluminum frame.
- For oil stains, it's recommended to use an environmentally friendly cleaner.

09 Maintenance of PV modules

Modules shall be inspected and maintained on a regular basis; during the warranty period it is an obligatory responsibility of the user. Any damage or other visible abnormalities of the module shall be reported to AIKO customer service upon discovery.

9.1 Cleaning

The power output of modules is related to incident light intensity and can be reduced by dust collection or other shadings. Dirt on modules must be cleaned up immediately.

The cleaning frequency depends on the degree of dirt collection. Modules installed at an adequate tilt angle will allow rainwater to clean the module surfaces, thereby reducing the cleaning frequency.

9.2 Visual checks of the modules

Visually checks for visual defects on modules, such as:

- Whether the module glass is broken;
- Whether the back cover of the module is cracked or otherwise abnormal;
- Whether the junction box is damaged or the cable is broken;
- Whether the module is shaded by foreign matter or shadows;
- Check whether the bolts fixing the module to the racking are loose or corroded and adjust or replace them if necessary;
- Check whether the modules are well-grounded

9.3 Checks of connectors and cables

It is recommended to perform preventive examinations every six months, such as:

- Whether the connectors are properly sealed and the cables are properly fastened;
- Whether the sealant of the junction box is cracked.

9.4 AIKO Technical Support

In order to request Technical Support:

- Collect evidences of the issue as (a) photos and (b) measurements
- Be prepared to show the purchase invoice and module serial number
Contact your Installer