

Warning Signs

About This Guide

Unboxing

Check Before Installation

What's in the Anker SOLIX Solarbank 2 E1600 AC Box

Optional Accessories

Overview

Product Overview

Button Controls

LED Guide

Installing Your Solarbank

Select an Installation Site

What You Need

Installation

Electrical Connections

Connecting Cables

*Connecting with FS20 Flexible Solar Panel (225W)

Turn On the Solarbank

Turn Off the Solarbank

Using the App

Download the App

Account Registration

Initialization Setting

Network Configuration

Add Home Devices (Optional)

Firmware Update



Power Mode Setting Initialization

Energy Plan Setting

FAQ

Specifications

Warning Signs

	This sign signifies the presence of high voltage danger and risk of electric shock.
	To prevent electric shock or personal injury, refrain from touching or using the inverter until 15 minutes have lapsed since its shutdown or disconnection.
	Refer to the operation instructions.

About This Guide

This guide shows the primary system for the whole-home photovoltaic energy cycle, with **Anker SOLIX Solarbank 2 E1600 AC** installed as the main service equipment. This guide describes **Anker SOLIX Solarbank 2 E1600 AC** in terms of unboxing, product overview, installation, electrical connections, button and light explanation, customer service, and safety guidelines.

- One **Anker SOLIX Solarbank 2 E1600 AC** can support up to 5 **Anker SOLIX BP1600 Expansion Batteries**.
- **Anker SOLIX Solarbank 2 E1600 AC** can be used with Anker SOLIX Smart Meter, Anker SOLIX Smart Plug and some third-party devices (update irregularly).

Unboxing

Check Before Installation

Check the Outer Packaging

Before unpacking the equipment, check the outer packaging for damage, such as holes and cracks, and review the equipment model number. If any damage is found or the model is not what you requested, do not unpack the equipment and contact Anker customer service as soon as possible.

Check Deliverables

After unpacking the equipment, check that the deliverables are intact and complete, and free from any obvious damage. If any item is missing or damaged, contact Anker customer service.

What's in the Anker SOLIX Solarbank 2 E1600 AC Box

Model: A17C2

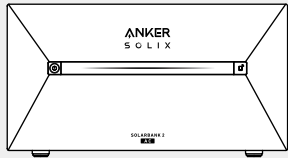

Anker SOLIX Solarbank
2 E1600 AC

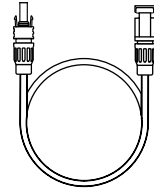

Anker SOLIX Solar Panel
Extension Cable (3m)
(x4)

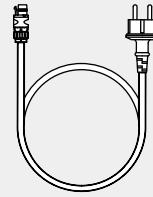

Anker SOLIX AC Cable with
Schuko (5m)

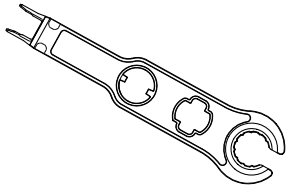

Wrench for Removing PV
Connectors

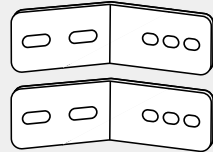

L-Shape Wall Mount Fitting
(x2)

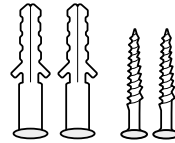

M5x60 Self-Tapping
Expansion Screws
(x2)



M5x10 Combined Phillips
Screws
(x2)

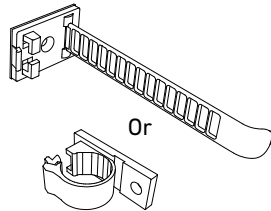

Or
Cable Organizer
(x4)

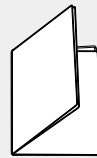

Important Safety
Instructions

Optional Accessories

 The following accessories must be ordered separately.

Anker SOLIX BP1600 Expansion Battery (Optional)

Model: A17C13Z1-85



Anker SOLIX BP1600
Expansion Battery

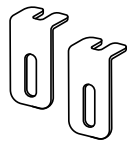

Fixed Bracket
(x2)

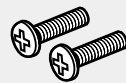

M5x10 Combined
Phillips screws
(x2)

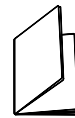

Important Safety
Instructions

Anker SOLIX Smart Meter (Optional)

Model: A17X7



Smart Meter

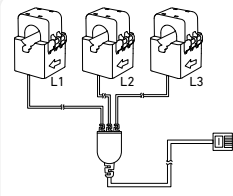

Current Transformer(1m)
(x3)

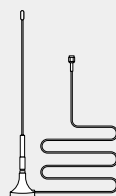

Extension Antenna

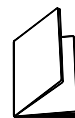

Important Safety
Instructions

Anker SOLIX Smart Plug (Optional)

Model: A17X8

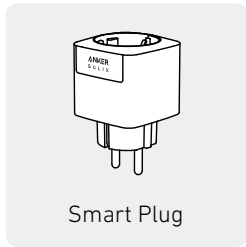

Smart Plug



Important Safety Instructions

Overview

Product Overview

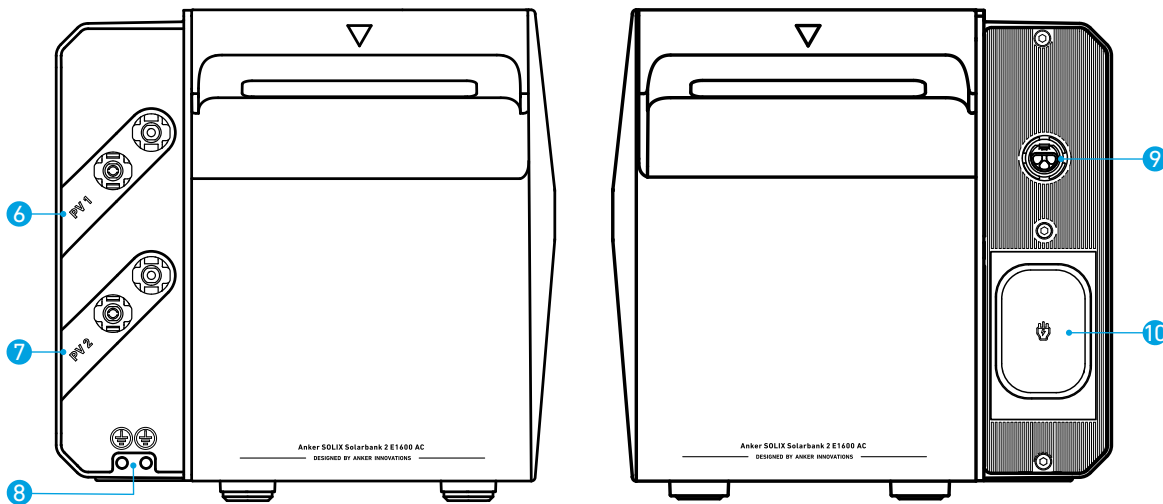
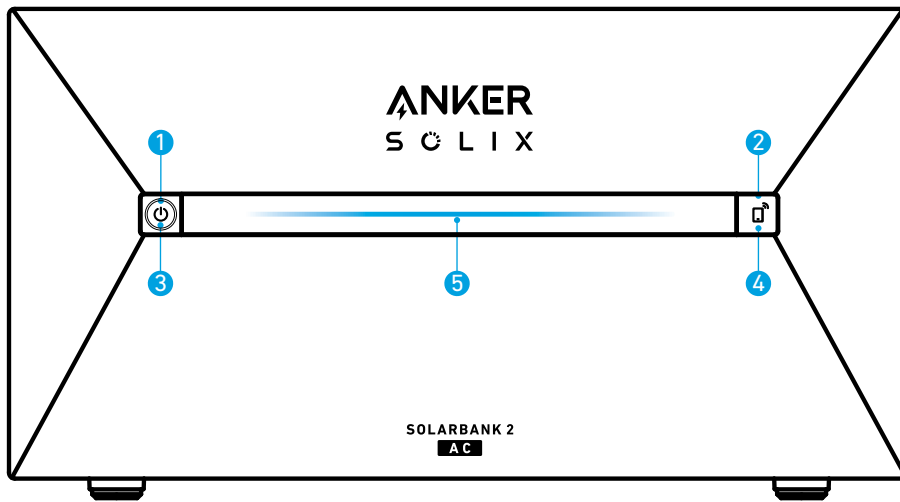

- 1 Power Button
- 2 IoT Button
- 3 Power Status LED
- 4 IoT Status LED
- 5 Working Status LED
- 6 PV Connector Ports for PV Input 1
- 7 PV Connector Ports for PV Input 2
- 8 Ground Screw Hole (Electric drill is needed)
- 9 Grid-Tied Terminal
- 10 Microinverter Input Port / Off-grid Output Port

Button Controls

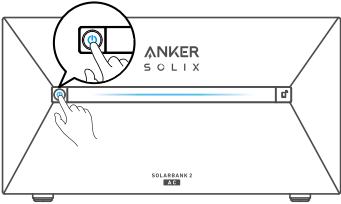
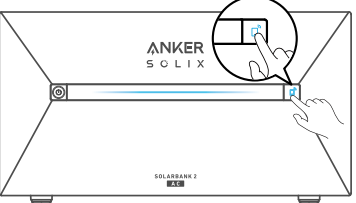
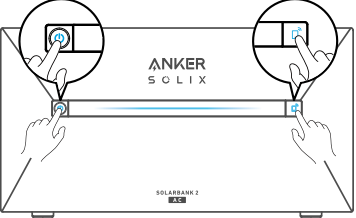
Button	Action	Function
	Press for 2 seconds	Turn on Solarbank
	Press for 2 seconds	Turn off Solarbank * Ensure that there is no voltage input from the PV to Solarbank.
	Press once when powered on	Check current battery level
	Press once	Enable Internet connection
	Press for 2 seconds	Disable Internet connection
	Press for 7 seconds	Reset Bluetooth and Wi-Fi
	Simultaneously press for 9 seconds	Reset Solarbank

LED Guide

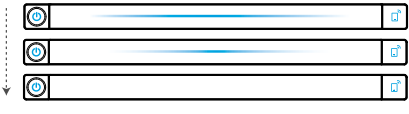
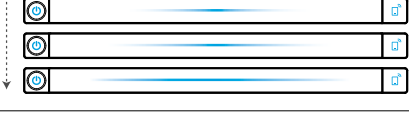
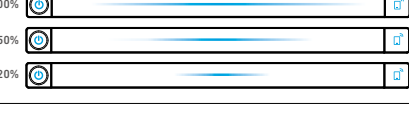
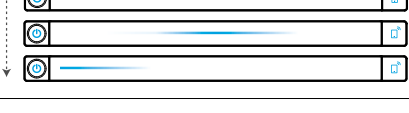
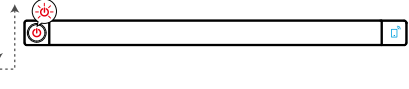
Light Bar	Description	Status
	The center LED lights up toward both sides.	Powered on
	The lights on both sides fade toward the center.	Powered off
	The LED lights up toward both sides, and then cycle again.	Recharging
	The light bar changes according to battery level.	Battery level
	The light runs from right to left.	Upgrading OTA
	The power button light flashes red.	Malfunction / Warning

Installing Your Solarbank



Do not use or turn on the Solarbank after it has come into contact with water.

Select an Installation Site

Environment Requirements

- Do not place the modules near an area exposed to direct sunlight, fire, or explosive materials.
- Ensure the site is protected from potential hazards such as floods.
- The maximum operating altitude is 4,000 m (13,123 ft).

Measure the Distance

Reserve sufficient space for heat dissipation and safety isolation.

1. Select the appropriate installation space according to the equipment configuration to be installed.

Anker SOLIX Solarbank 2 E1600 AC							
	Expansion Battery Module	0	×1	×2	×3	×4	×5
	Capacity	1600Wh	3200Wh	4800Wh	6400Wh	8000Wh	9600Wh
	Rated Charging Power	1000W	2000W	2400W	2400W	2400W	2400W

2. Equipment Dimensions Figure:

Figure: Anker SOLIX Solarbank 2 E1600 AC

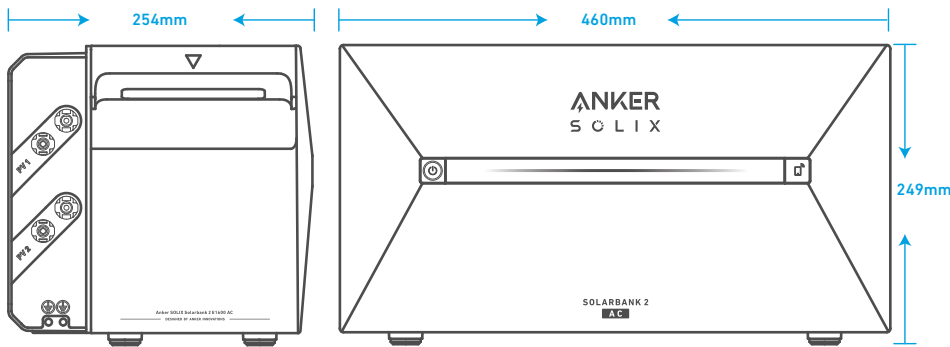
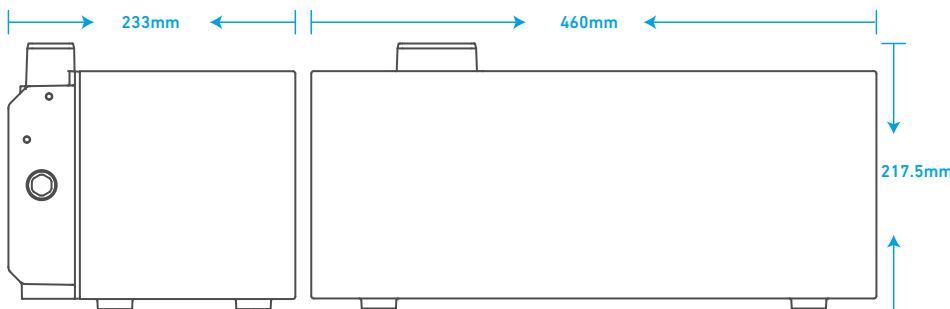
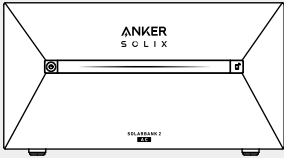

Figure: Anker SOLIX BP1600 Expansion Battery



What You Need



Anker SOLIX Solarbank
2 E1600 AC



Multiple Anker SOLIX
BP1600 Expansion Batteries

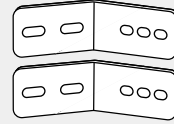

L-Shape Wall Mount Fitting
(x2)

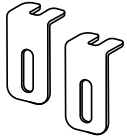

Fixed Bracket
(x2)

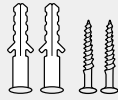

M5x60 Self-Tapping
Expansion Screws
(x2)

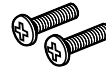

M5x10 Combined Phillips
Screws

 Note: The following components are not included in this package. Please make sure they are ready before installation and electrical connection.

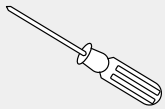

Phillips Screwdriver

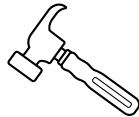

Hammer

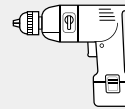

Drill
(Screw Torque: 2N·m)

Installation

The steps below describe the installation of one Solarbank 2 E1600 AC and two Expansion Batteries as an example.

1. Place one expansion battery on the floor 30mm from the wall.

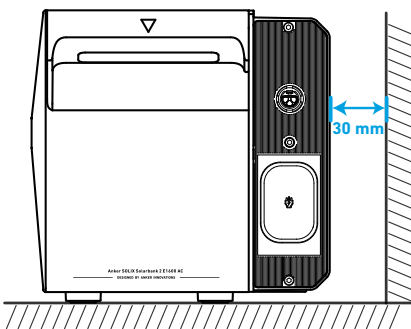

2. Use a Phillips screwdriver to remove screws and pry open the rubber plug at the bottom of Solarbank.

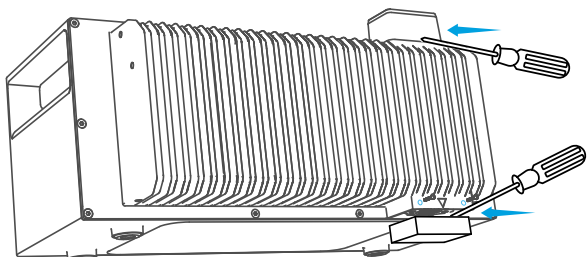
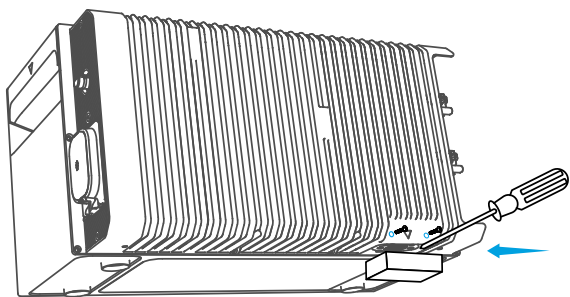

💡 Note: When installing the bottom battery pack or only one Solarbank, please do not remove the bottom rubber plug to avoid water damage to the equipment.

3. Stack expansion batteries in sequence with Solarbank at the top by inserting the two corresponding ports into each other.

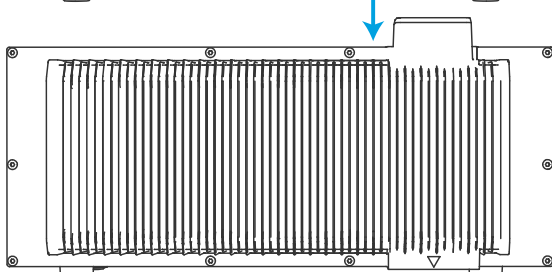
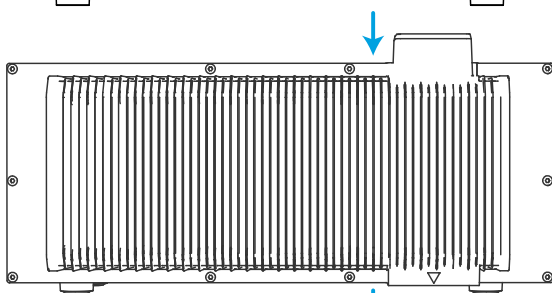
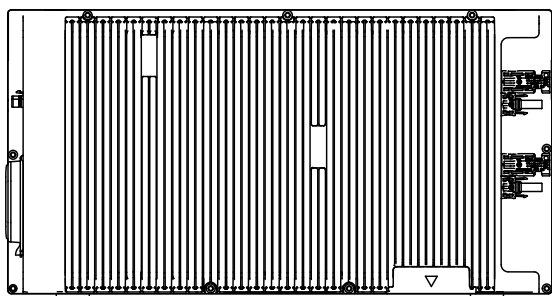

4. Pre-fasten the L-Shape Wall Mount Fitting to both sides of the first expansion battery under Solarbank using M5×10 combined Phillips screws.

💡 Note: The L-Shape Wall Mount Fitting can be mounted on the front or the back.

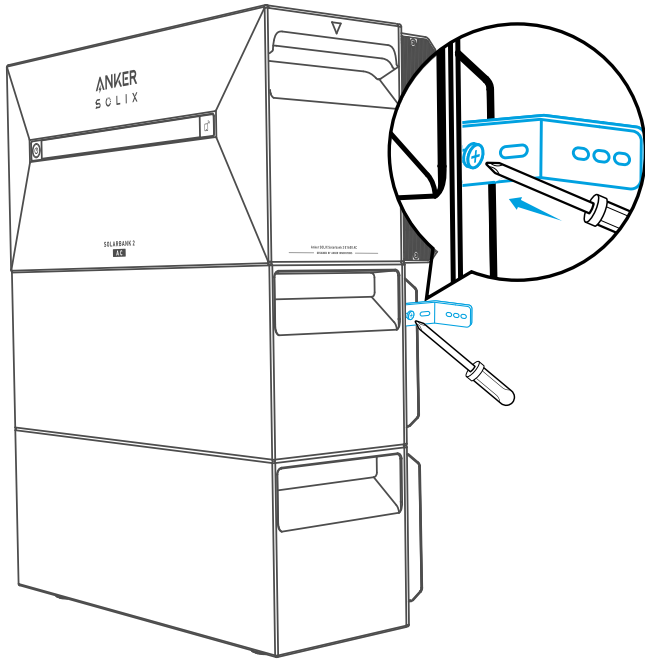

5. Mark the position of drilling holes on both sides and use a drill with a $\phi 8$ drill bit and a depth of 60mm.

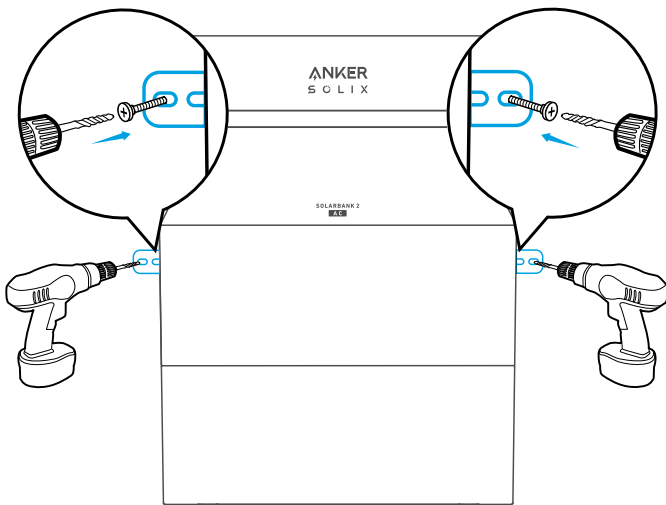

6. Use a hammer to tap the plastic sleeve of the M5×60 self-tapping expansion screw into the hole, and then use a Phillips screwdriver to fasten the M5×60 self-tapping screw against the L-Shape Wall Mount Fitting.

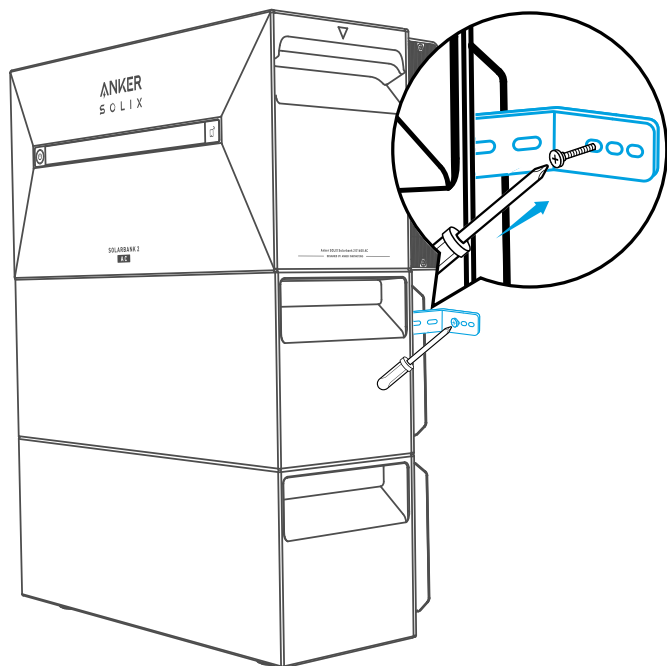

7. Use a Phillips screwdriver to fasten the M5×10 combination Phillips screws against the L-Shape Wall Mount Fitting; then secure the interlocking bracket to the expansion battery using the M5×10 combined Phillips screws to complete the installation.

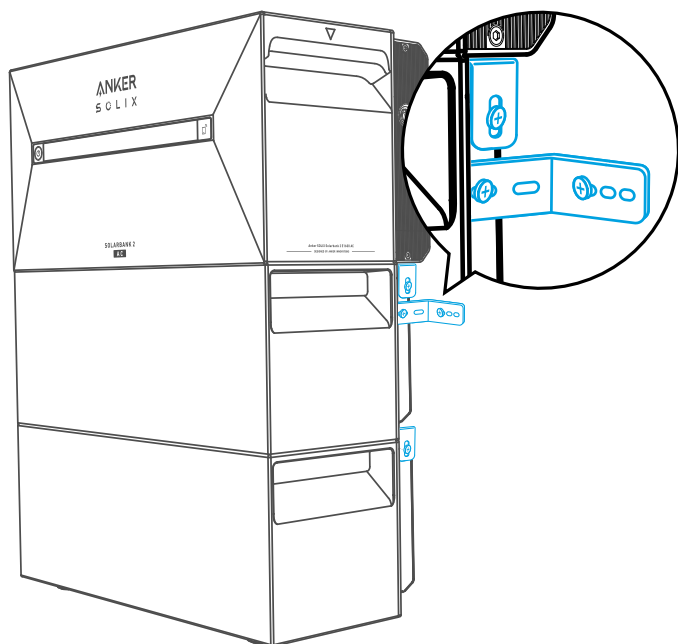

💡 Note:

- The grid connection must be connected to a socket with grounding, otherwise there is a risk of electric shock. Alternatively, the casing should be grounded. The grounding point is shown below.

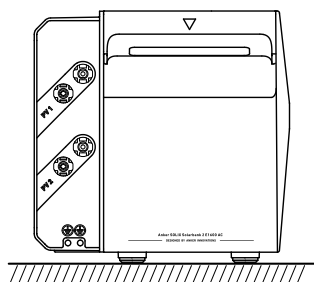

- This product includes a double isolation transformer, which meets safety requirements without array ground insulation resistance measurement and array residual current detection.

Electrical Connections

Connecting Cables

The steps below describe the installation of one Solarbank 2 E1600 AC with two solar panels as an example.

 *Note: Anker SOLIX Smart Meter, Anker SOLIX Smart Plug and Anker SOLIX BP1600 Expansion Battery can be purchased optionally.*

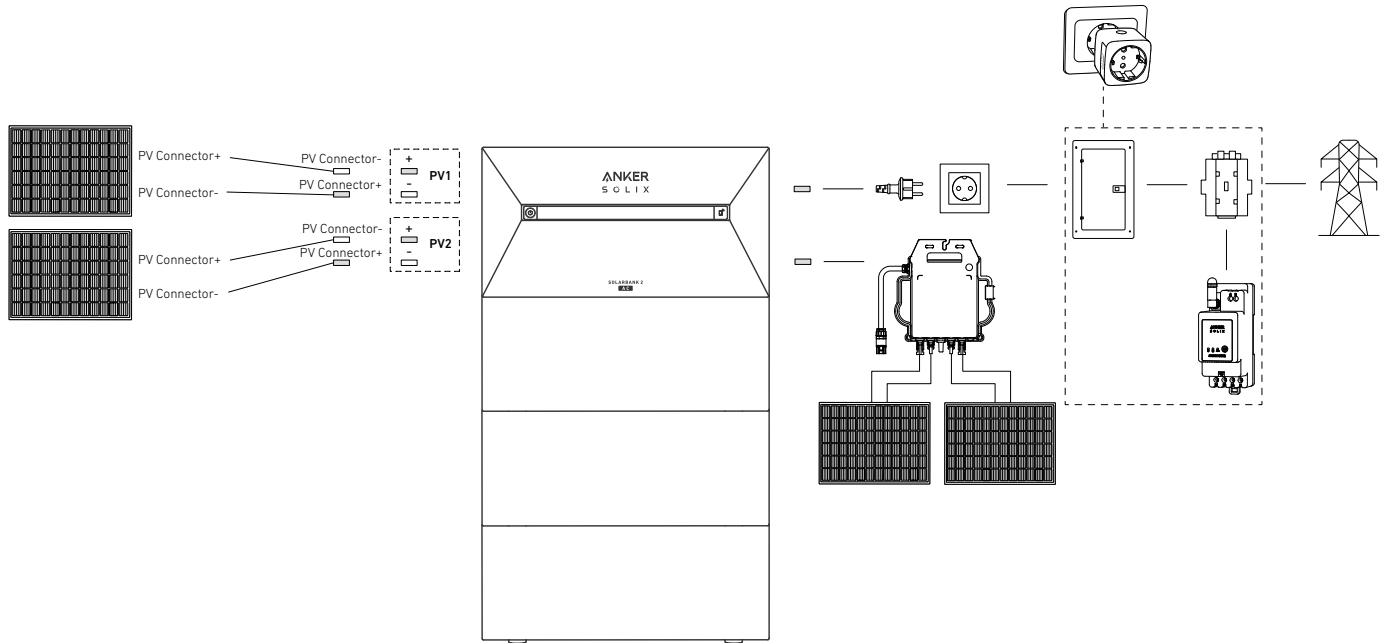

1. Connect Solarbank to the microinverter or a home outlet using the included AC Cable with Schuko plug (5m).

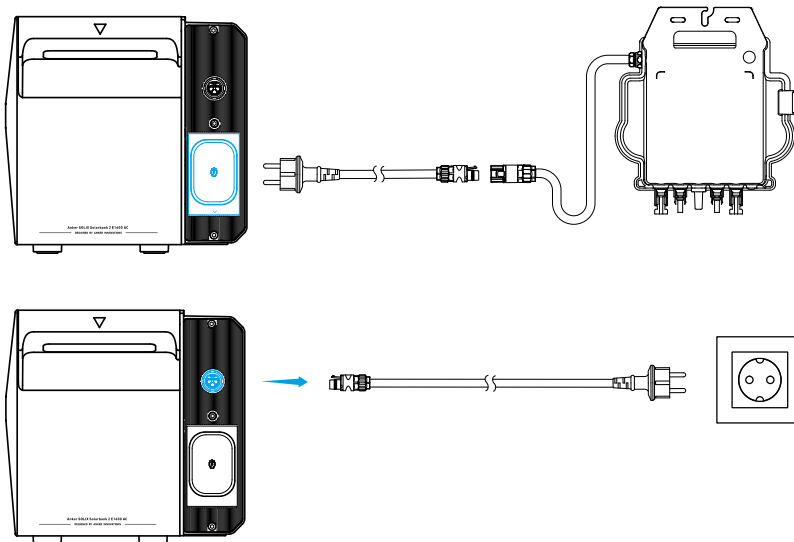

2. Find the PV connector ports of your solar panels.

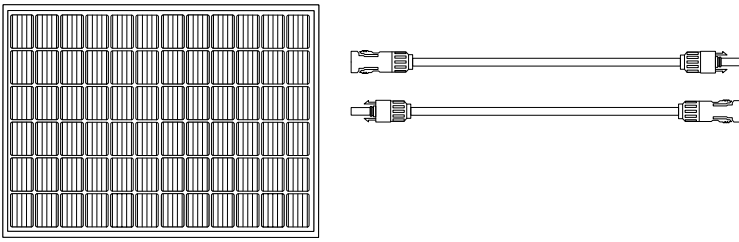

3. Connect each set of PV modules to each set of PV input ports in Solarbank using the included Anker SOLIX Solar Panel Extension Cable (3m).

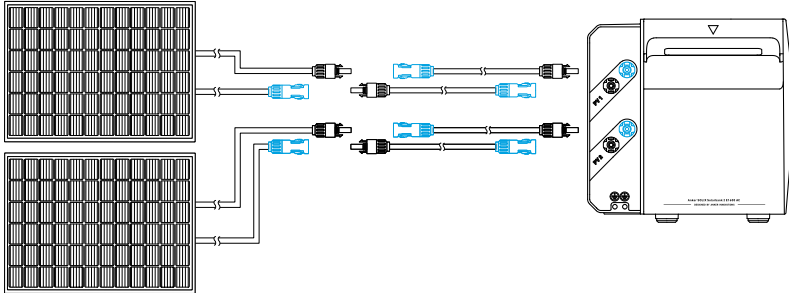

	<p>Solar Panels Anker SOLIX Solarbank 2 E1600 AC</p>
<p>Never connect two or more components in series because this causes the input voltage to exceed 60V and will damage the equipment.</p>	

*Connecting with FS20 Flexible Solar Panel (225W)

Install 4 solar panels with Y Solar Connection Cables. With parallel connections, the female connectors of two solar panels are connected to the two male connectors of a Y Solar Connection cable, while the male connectors of the other two solar panels are connected to the two female connectors of another Y Solar Connection Cable.

Note: FS20 Flexible Solar Panel has high open circuit voltage and cannot be used in series. The input voltage can't exceed 60V and the current can't exceed 16A, or it will damage the Solarbank.

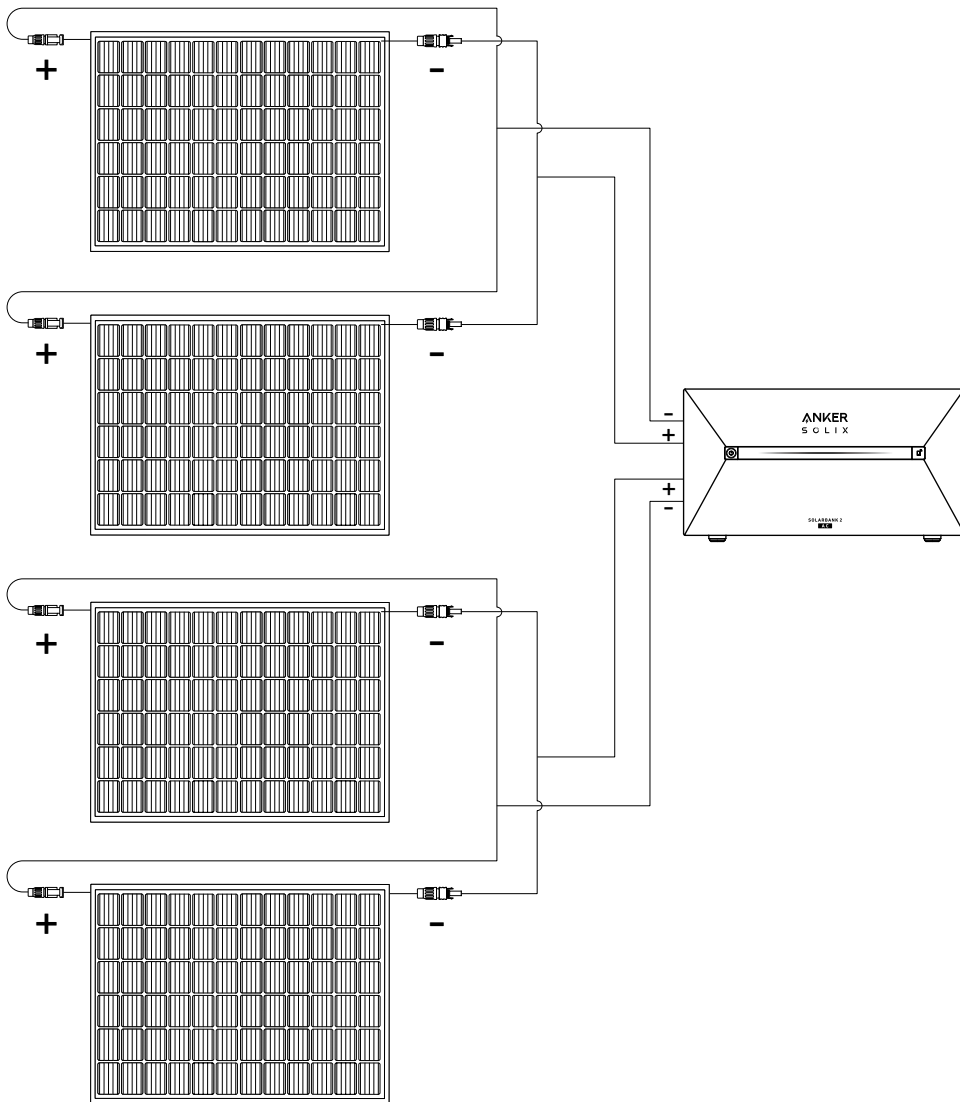

Turn On the Solarbank

1. Connect the Solarbank with the microinverter, the solar panel and a home outlet.

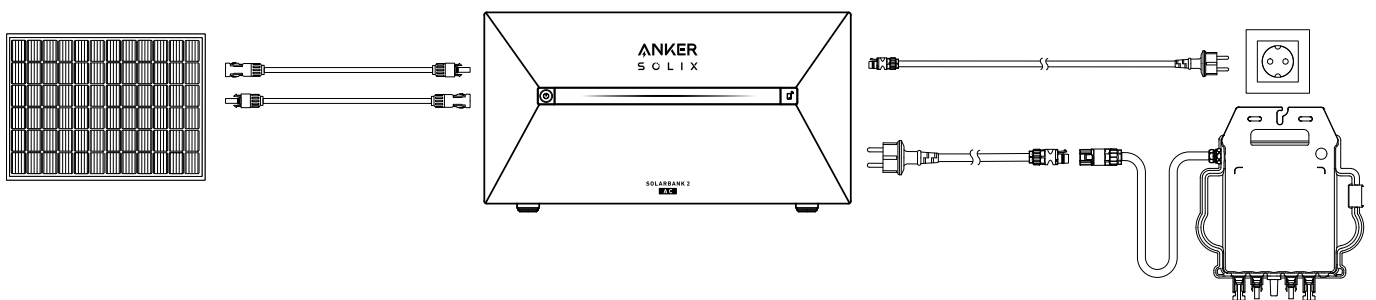

2. When you use it at night, you can press and hold the power button on the solarbank for 2 seconds to turn it on, which will enable network pairing. Please complete the network pairing with the app within 30 minutes. If the network pairing is not completed within 30 minutes, the Solarbank will automatically turn off.

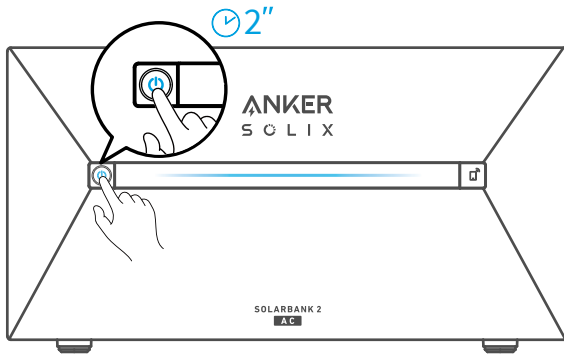

Turn Off the Solarbank

* If you want to turn off the Solarbank during the day, please use the wrench to remove the solar panel extension cables on the device side and press the power button for 2 seconds.

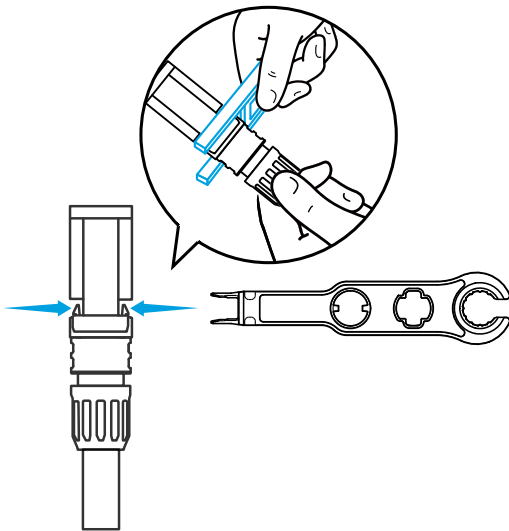

* If you want to turn off the Solarbank at night, please press the power button for 2 seconds.

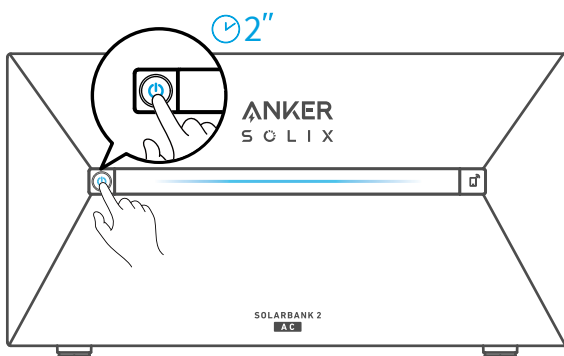

Using the App

Download the App

Search "Anker" and download the App via App Store or Google Play. Or scan QR code below to go to the corresponding application store.

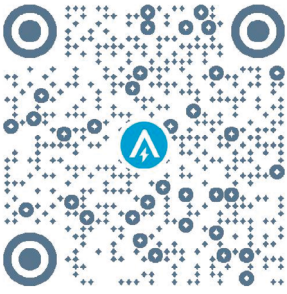

Account Registration

Region Selection

When the app is launched, you will head to the login page.

Please be reminded that the country region **MUST** match where you live. An incorrect country region may cause the device connection to fail.

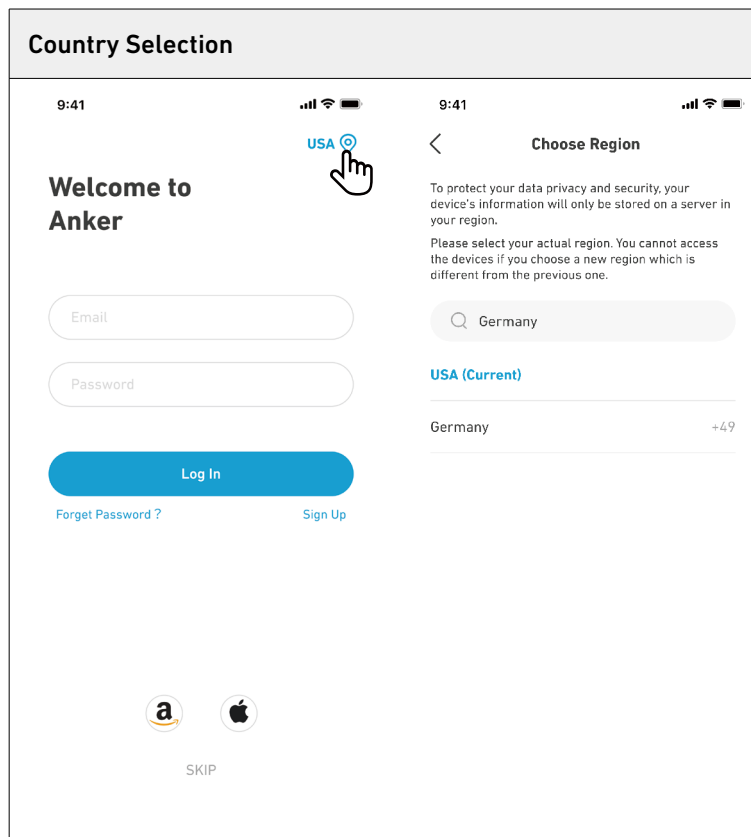

Sign Up / Sign In

You can login via Anker account, Amazon, or Apple ID.

If you do not have an Anker account, you can tap [Sign Up] to register an account:

Please prepare an email for the registration process. Passwords must contain 8-20 characters using uppercase and lowercase letters, numbers, and symbols.

Initialization Setting

Network Configuration

Before configuring, please ensure the network connection is working well with a strong Wi-Fi signal. Do not place the device far away from the router.

Step 1

If Solarbank is powered off, press the left button on the device for 2 seconds to turn it on.

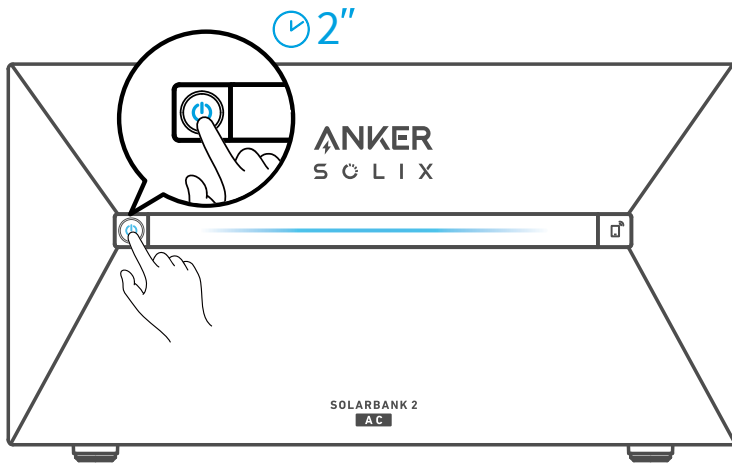

Step 2

Press the right button on the device, enable Wi-Fi mode.

- When the IoT light flashes, the device is in Configuration mode.
- If the device has configured Wi-Fi and you wish to reset it, you may hold the IoT button for 7 seconds.

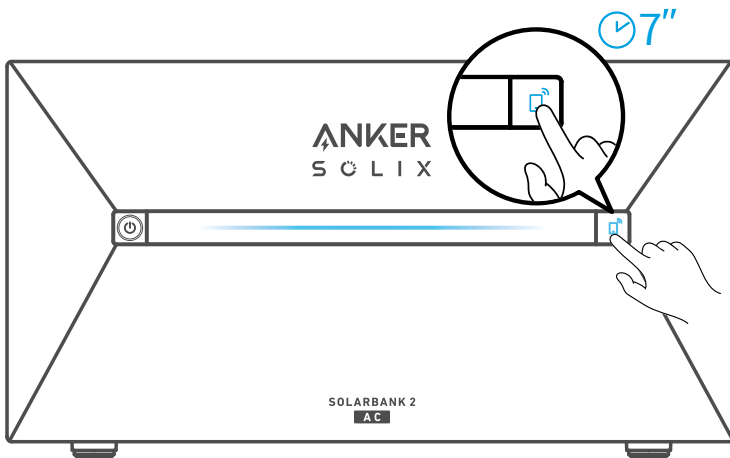

Step 3

1. Ensure that the IoT light is flashing.
2. Tap [+] or [Add Device] at the top right corner of Devices page.

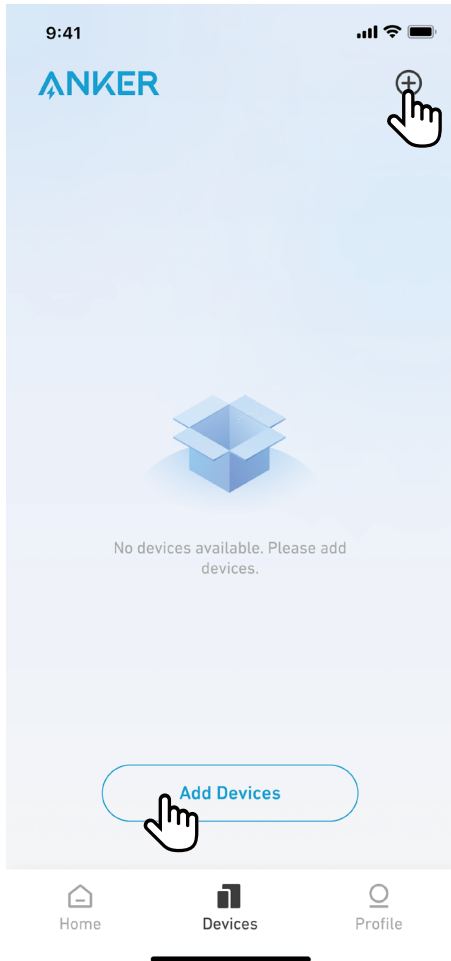

Step 4

The Anker App will automatically search for your Solarbank. Once the device is found, it will appear on the list.

- Please make sure your phone's Bluetooth is on, and the Anker App is authorized to access Bluetooth and Wi-Fi.
- If you wish to manually search for the device, you can tap [Balcony Solar System] in the "Add devices manually" row.

9:41



Add a device

1 device detected



Solarbank 2 E1600 AC

Add devices manually



Step 5

After connecting Solarbank via Bluetooth, you should choose a Wi-Fi network for the device. Select the Wi-Fi network from the list and enter the password.

- The device only supports 2.4GHz Wi-Fi.
- Make sure the password is correct.

9:41



Select Wi-Fi

This device only supports 2.4GHz Wi-Fi.
If you have Dual Band Wi-Fi, please use the 2.4GHz band.
The Wi-Fi name only supports alphanumeric characters.

Family-Network



Enter Wi-Fi Password



[Turn on Personal Hotspot >>](#)

Next

[Use Bluetooth Control](#)



Step 6

Your Solarbank should successfully be configured to the network.

If the configuration process fails, follow the tips below:

- Check if the Wi-Fi router is working normally.
- Move the router closer to the device.
- Make sure the Wi-Fi password is correct.

9:41



Successful

Solarbank 2 E1600 AC



Successfully deployed Wi-Fi

Done

Add Home Devices (Optional)

If you have purchased Anker SOLIX Smart Meter or Anker SOLIX Smart Plug, please scan QR codes below for more details.



Anker SOLIX Smart Meter



Anker SOLIX Smart Plug

Anker SOLIX Smart Meter and Anker SOLIX Smart Plug can be added to the home system by following the process below. If you do not need to add any devices, you can skip the process by clicking [Skip].

1. Click [Start] to begin the process of adding home devices.
2. Select the devices that have been bound to the current account. If you want to add devices that have not been bound to the account, then click [Add Devices].
3. Follow the process guide to activate the Smart Meter and Smart Plug Bluetooth and pair them with Wi-Fi.
4. After pairing the Smart Meter or Smart Plug, return to the [Add Devices] interface. At this time, you can see the Smart Meter or the Smart Plug in the list.
5. Select the Smart Meter or Smart Plug to add it to the system.

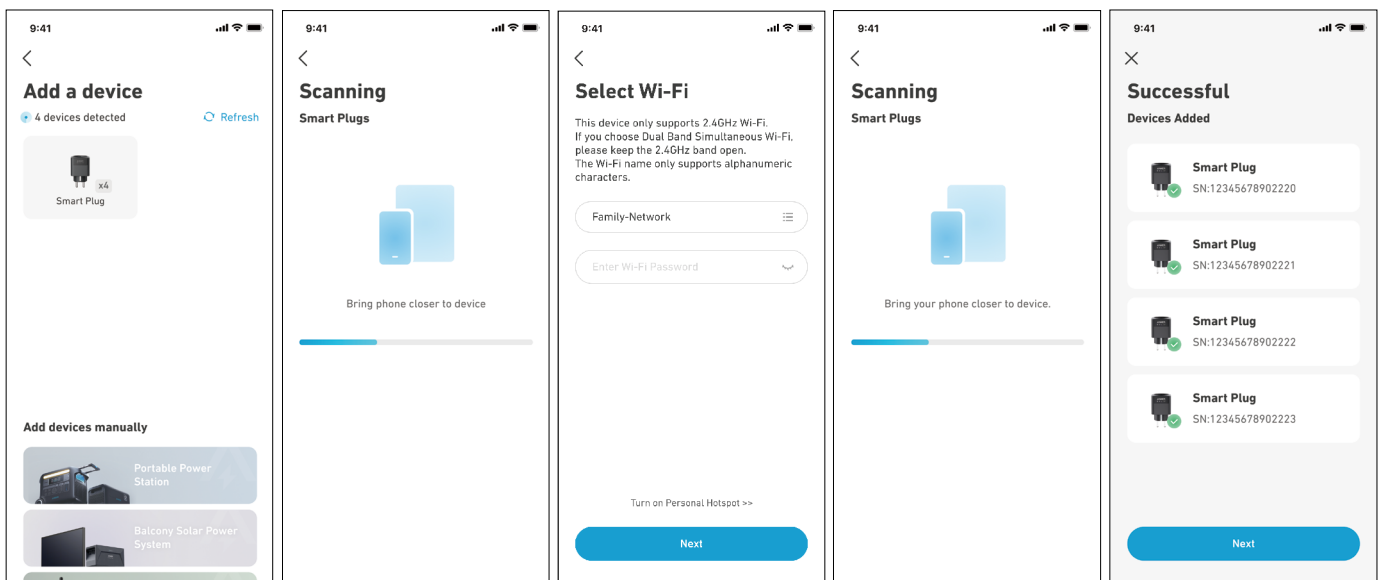
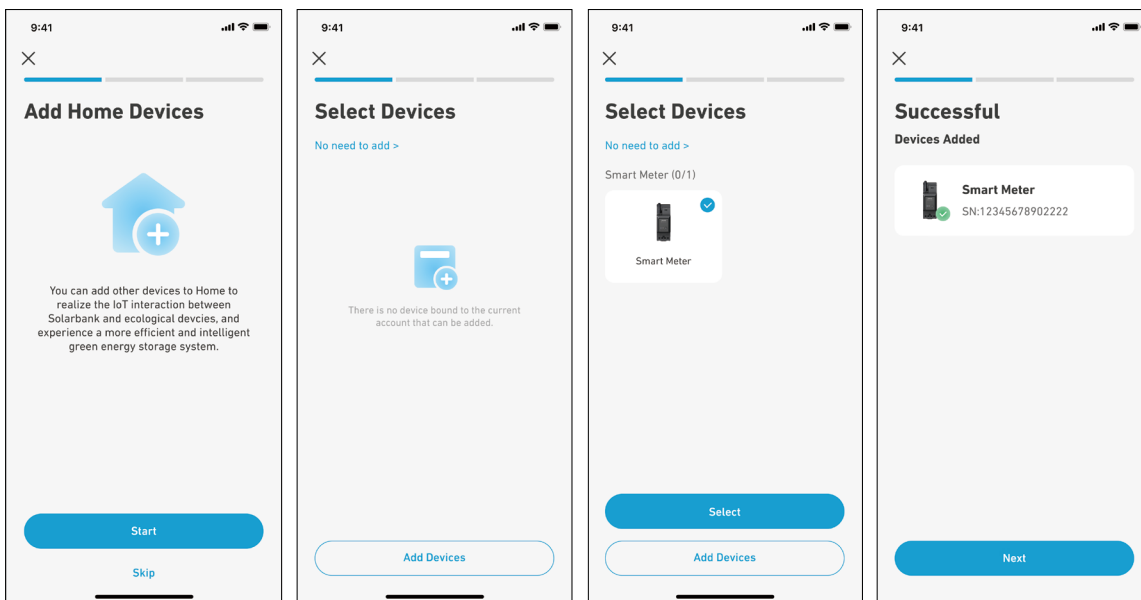

Firmware Update

Make sure all your devices have configured Wi-Fi and have a stable network connection.

1. If there is an important update for the firmware of Solarbank or Smart Meter, the app will guide you through the process. Make sure your devices are on and connected to Wi-Fi before updating.
2. If no update is required, you can skip this step.

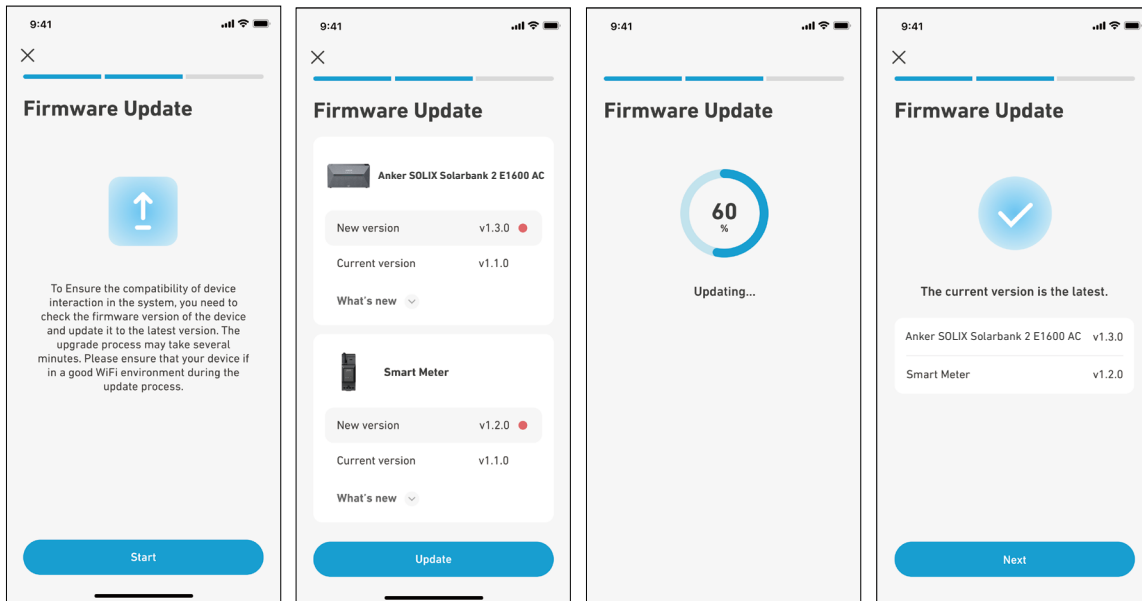

💡 Note: Updates can take a few minutes. Please be patient. If the update fails, check if your devices are activated and connected to Wi-Fi.

Power Mode Setting Initialization

1. Tap [Create] to create a system for the previously added device.
2. You can initially set up the system's energy plan with the following options:

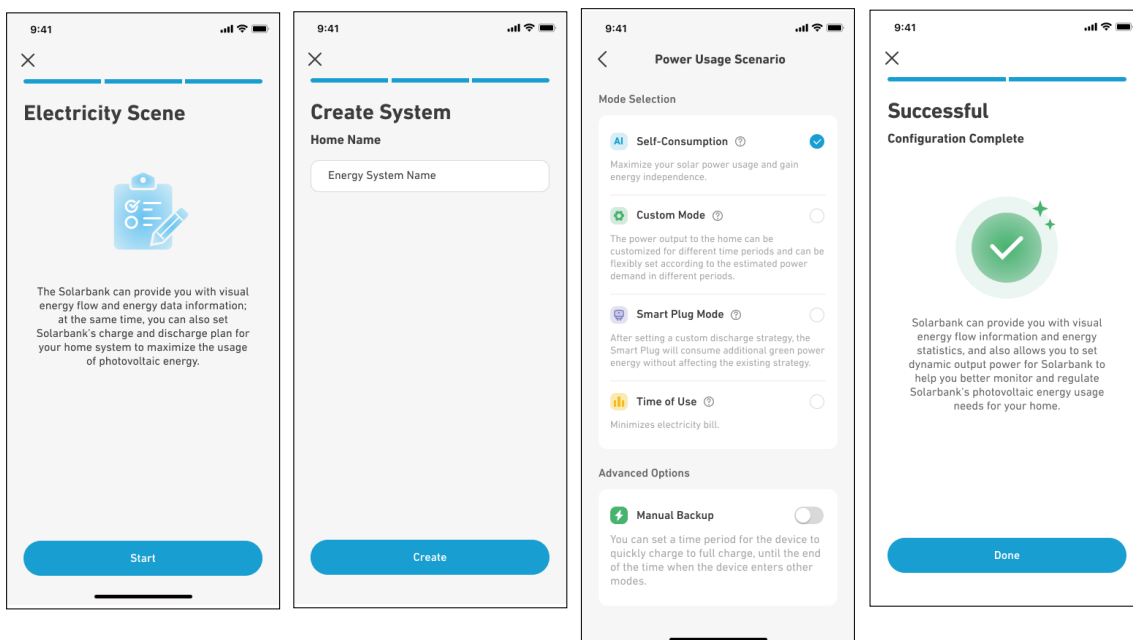

💡 Note: Self-Consumption mode is only available when the Smart Meter is added to the system.

Energy Plan Setting

About Energy Plan

In the Solarbank 2 E1600 AC system, you can set up a charging and discharging plan. Solarbank will output the necessary amount of power to household loads at different time periods through the preset plan, and extra energy can be stored in Solarbank for reuse during the peak period of electricity consumption. This helps maximize use of solar energy.

Once you have configured the Smart Meter, you can also select Self-Consumption mode. The meter will intelligently manage Solarbank's discharging and energy storage in real time by obtaining only the amount of electricity required by household loads, not wasting solar energy.

Select Mode

Access mode selection from the Energy Plan shortcut on the Home page:

- **Self-Consumption:** Solarbank will intelligently charge and discharge based on real-time power demand required by household loads determined from the Smart Meter.

 *Note: Self-Consumption mode is only available when the Smart Meter is added to the system.*

- **Custom Mode:** You can set up a schedule for Solarbank to discharge a fixed amount of power into your home load at different time periods, and extra energy will be stored in Solarbank.
- **Smart Plug Mode:** After setting a custom discharge strategy, the Smart Plug will consume additional green power energy without affecting the existing strategy.
- **Time of Use:** The battery modules will charge when utility rates are the lowest, and power your home when utility rates are the highest. Make sure to edit your utility rate plan for weekdays and weekend.
- **Manual Backup:** You can set a time period for the device to quickly charge to full charge, until the end of the time when the device enters other modes.

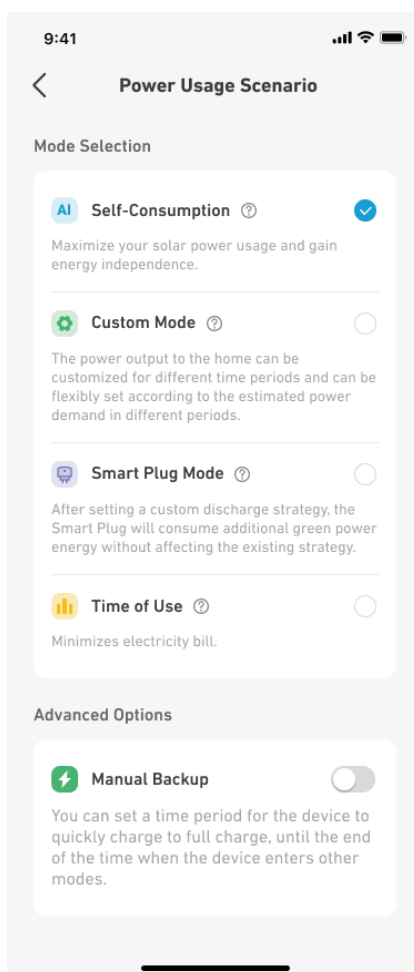
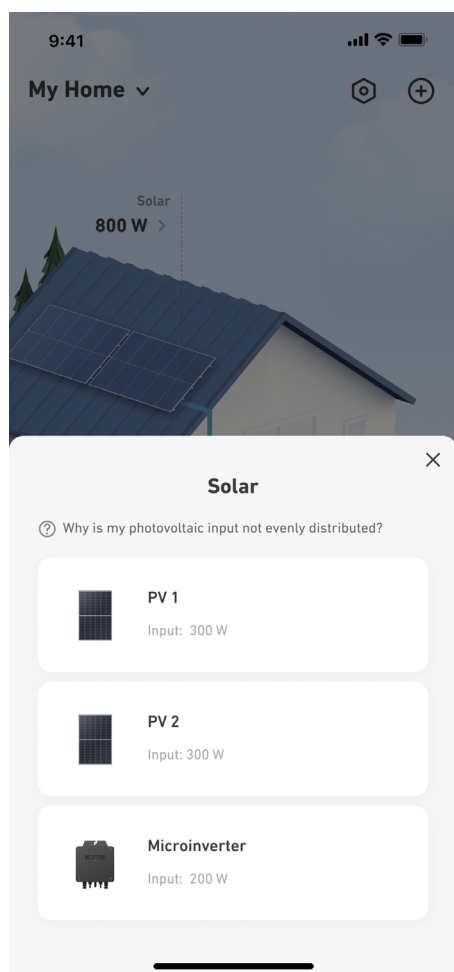

Custom Mode

Select Custom Mode, then click the button below it:

1. Tap [Settings] to enter the Energy Plan setting page, which will list all the plans you have set up. If there is no plan, Solarbank will discharge 200W to home loads at all times.
2. Click [+] in the upper right corner to add an energy plan.
3. On the Energy Plan page, click [Set a Schedule] to set the power that Solarbank discharges to household loads for different time periods.
4. Tap [Repeat] above to repeat the set discharge plan for other weeks.
5. After completing all settings, tap [✓] in the upper right corner to save and apply the Energy Plan.

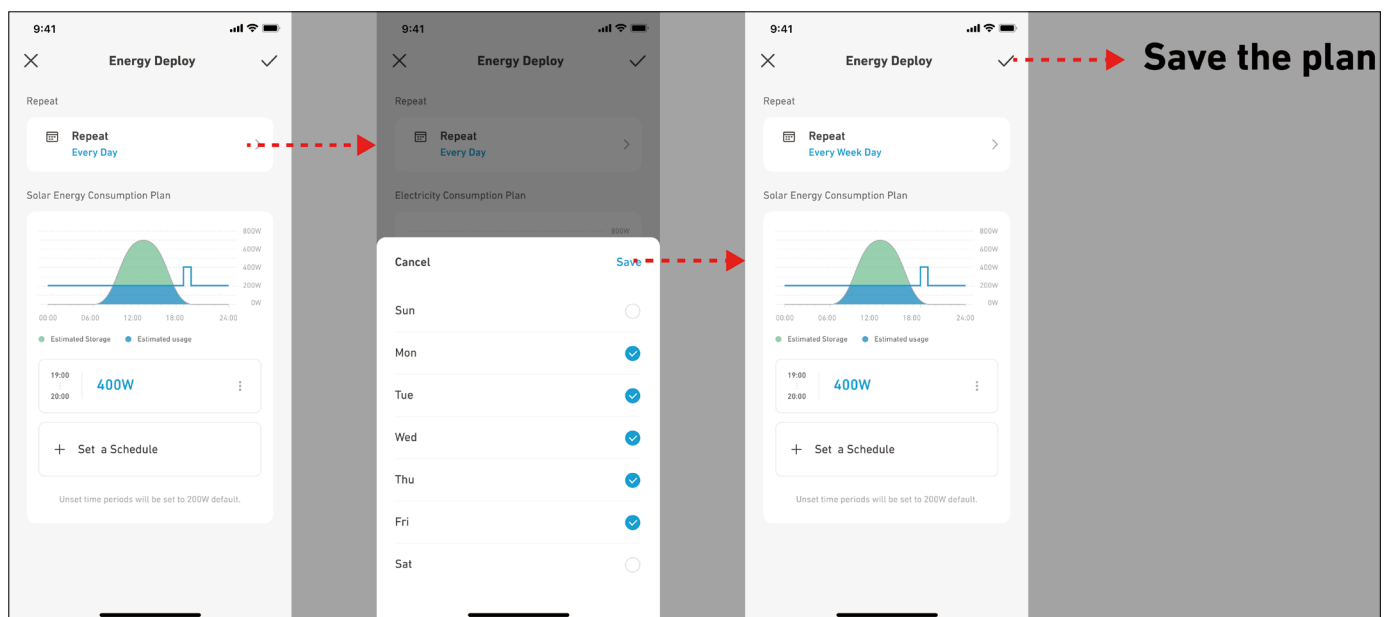
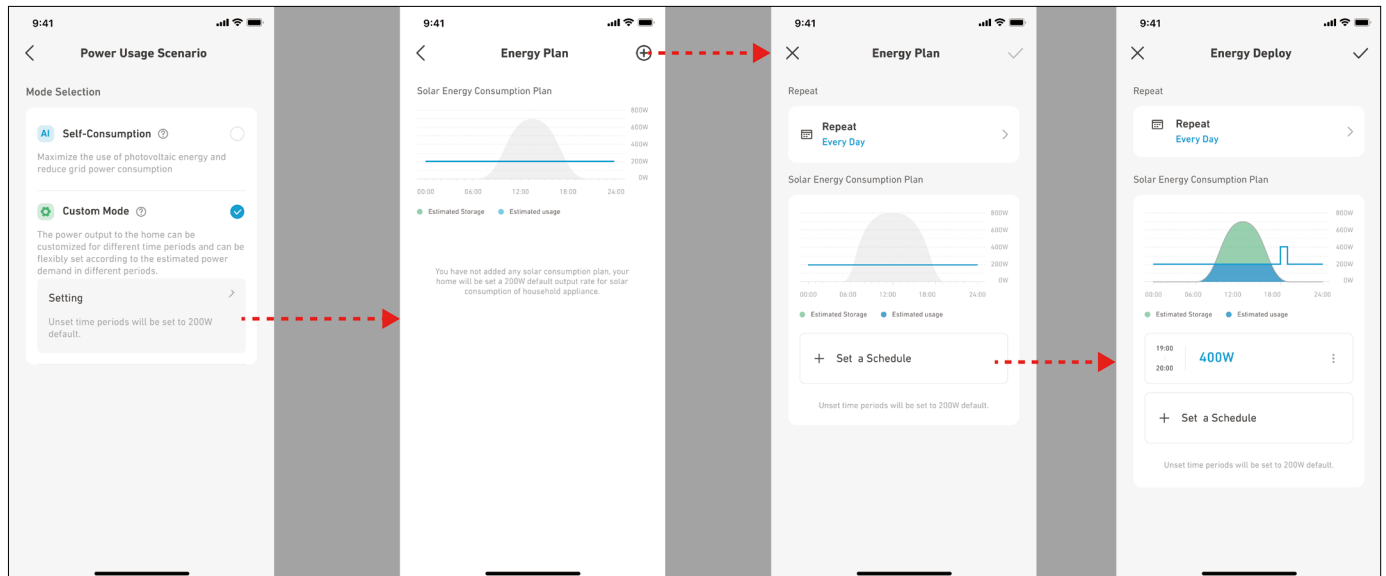

💡 Notes:

- You can add Energy Plan for multiple devices with different recurring dates.
- Ensure that your device is connected to Wi-Fi when you save an electricity usage plan to synchronize the plan.
- In Self-Consumption mode, if the Smart Meter goes offline or malfunctions, Solarbank automatically switches to Custom mode as a backup energy plan. This lasts until the Smart Meter returns to normal, and then Self-Consumption mode automatically resumes.

FAQ

Q1: What precautions should I take before installing/adding expansion batteries?

When installing/adding expansion batteries, it is necessary to power off and shut down the system to protect yourself and the machine. Performing this operation while powered on is not covered under warranty. Please follow the steps below for proper installation:

- a. Disconnect Solarbank and the solar panels.
- b. Press the on/off button for 3 seconds to turn off the power.
- c. After turning off Solarbank, install the expansion batteries to Solarbank.
- d. Connect solar panels for normal use.

Q2: Are there any other precautions that need to be taken when installing and using Solarbank 2 E1600 AC?

Ensure the AC outlet is properly grounded. Otherwise, you'll see "Error Code 54: Ground Fault." Your safety could also be at risk if this component is not properly grounded.

Q3: Can the photovoltaic panels be connected in series?

No. Never connect two or more components in series because this causes the input voltage to exceed 60V and will damage the equipment.

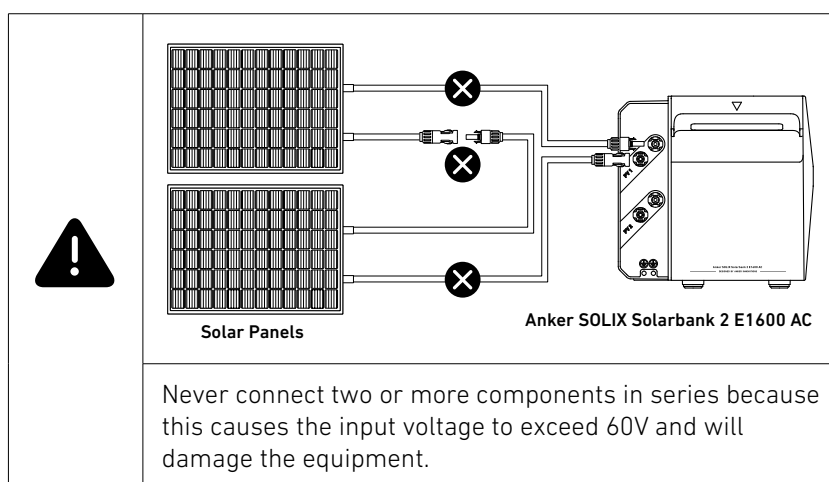

Q4: Are microinverters required to use Solarbank 2 E1600AC?

Solarbank 2 E1600 AC doesn't require a microinverter. A microinverter is already built into the design. Solarbank 2 features 2 MPPT, but you can add another microinverter for more solar input.

Q5: How much microinverter power can be connected to Solarbank 2 E1600 AC?

800W maximum. German regulations limit balcony photovoltaic systems to 800W, so we recommend using a compliant microinverter. If your microinverter power exceeds 800W, please lower it to at most 800W.

Q6: How does a smart meter help Solarbank 2 E1600 AC achieve zero energy waste?

The smart meter detects household electricity consumption, which lets Solarbank 2 E1600 AC continually adjust output. This precise discharge achieves efficient energy use. Solarbank 2 can only connect to one smart meter. Use Wi-Fi to connect.

Q7: How do smart plugs help Solarbank 2 E1600 AC achieve zero energy waste?

In Custom mode, the smart plug uses extra PV power without affecting the energy discharging strategy. Each Solarbank 2 AC can connect to up to 6 smart plugs. Use Wi-Fi to connect the devices.

Q8: Can I use Solarbank 2 E1600 AC with a smart plug and a smart meter at the same time?

You can use a smart meter and a smart plug at the same time, but only one mode can be used to control them.

In Self-Consumption mode, Solarbank 2 AC follows the smart meter's data.

In Smart Plug mode, Solarbank 2 AC follows the smart plug's data.

Q9: Does Solarbank 2 E1600 AC need to be connected to a Wi-Fi network and the Anker app?

To adjust the output of Solarbank 2 from 200W, you need to use the Anker app. To check its status and connect to Anker SOLIX Smart Meter and Smart Plug, you need to use Wi-Fi.

Q10: Can I set up a dual system with Solarbank 2 E1600 AC, such as connecting with Solarbank E1600?

No, Solarbank 2 AC functions by itself. Stack up to 5 batteries for 9600Wh. You can connect it to an external microinverter, but it can't be added to the same system. Data will show its input though.

Q11: Why can't I use the expansion battery pack after connecting it?

Before using, update both Solarbank 2 AC and the battery's firmware to the latest version. Power them on together and connect to the Anker app to initialize. If Solarbank initializes first, the battery firmware can't be updated.

Q12: How is Solarbank 2 E1600 AC and an expansion battery charged and discharged?

Solarbank 2 E1600 AC and an expansion battery work as a regulated system, dynamically adjusting the charging and discharging of the battery. It's normal for batteries to have slightly different performances.

Q13: What is the charging power of Solarbank 2 E1600 AC with different battery packs?

Charging power is based on current, maxing out at 70A.

Battery Charging: Main Unit = 1000W, + 1 Pack = 2000W, + 2 to 5 Packs =2400W.

MPPT Max Input: 1200W.

AC Charging: Main Unit = 1000W, + 1 to 5 Packs = 1200W.

Q14: What should I consider when installing a smart meter? How does Anker SOLIX Smart Meter monitor energy consumption? Does it use an optical interface? Does Anker SOLIX Smart Meter require a separate power connection?

Smart Meter connects via AC cables and CT for current collection, measuring power and sending data to Solarbank 2 E1600 AC via Wi-Fi.

Installation Notes:

1. CT is on the main line.
2. Voltage and current phases match.
3. CT is in correct direction.

Q15: Can I use Solarbank 2 AC during a power outage?

Yes, the MPPT PV power continues to charge Solarbank 2 AC, but microinverter PV power cannot.

To go off grid, unplug the microinverter and activate Off-Grid in the app.

The integrated socket supports 1000W by itself or 1200W with a battery.

Q16: Why can't my microinverter charge Solarbank 2 AC during a power outage?

The microinverter only works when connected to the grid. It is not active during an outage. This is unrelated to Solarbank 2 AC system.

Q17: Can I connect my solar panels to Solarbank 2 E1600 AC?

Each MPPT supports up to 16A and 60V. If your solar panels operate within these limits, they can be connected.

Q18: Does Solarbank 2 E1600 AC (A17C2) work with Solarbank E1600 (A17C0)?

No.

Q19: Is Solarbank 2 E1600 AC waterproof, and can it still be used if water gets inside?

Solarbank 2 AC is rated IP65, so it is protected against water in normal conditions. If water accidentally gets inside, do not use or turn it on. Contact Anker SOLIX customer service immediately.

Q20: Who installs smart meters?

Professional electricians can install Anker SOLIX Smart Meter. We strongly recommend this if you're not familiar with electrical installation. Incorrect installation can damage equipment and cause malfunctions or injury.

Q21: Is there a distance requirement between a smart meter / smart plug and Solarbank 2 E1600 AC? Does a smart meter / smart plug require Internet connection or network coverage?

A smart meter / smart plug communicates with Solarbank 2 E1600 AC via Wi-Fi and requires a LAN connection for Self-Consumption mode. These products must be on the same LAN. Place them within 10m of the same router or use a repeater. Only 2.4GHz Wi-Fi is supported.

Q22: Can I connect multiple Solarbank 2 E1600 AC units to one smart meter?

No, only one smart meter can communicate with one Solarbank 2 E1600 AC at a time.

Q23: Does the Solarbank 2 E1600 AC grid-tied port work with other solar power components?

No. For example, connecting a microinverter to the grid-tied port would result in unrecognizable power by the system and display inconsistent data.

Q24: Why is my Solarbank 2 E1600 AC charging value higher than the input value?

There may be other solar power system devices in your home charging the battery. Please check for any additional solar power system devices besides Solarbank 2 E1600 AC.

Q25: What is the battery reserve for Solarbank 2 E1600 AC and its expansion battery?

Choose between 10% or 5% reserve charges. If 10% is chosen, discharging stops at 10%, but the battery will not shut down until it reaches 4%. Once discharging stops, power drops by about 1% over 24 hours.

Q26: Is it possible to link Solarbank 2 E1600 AC energy production and power consumption data into loBroker or Home Assistant?

No, Solarbank 2 E1600 AC only supports management through the Anker app and is unable to connect to third-party systems.

Q27: What should I do if the app shows error code 32: abnormal electric meter?

The communication between the smart meter and the Solarbank is abnormal, and it has exited the self-consumption mode. Please check the Wi-Fi connection status of both the smart meter and the Solarbank.

Please try the following steps:

1. Make sure the smart meter and the Solarbank 2 E1600 Pro/Plus are connected to the same Wi-Fi network.
2. Make sure the router uses 2.4GHz communication, as the Solarbank 2 E1600 Pro/Plus and smart meter do not support 5GHz Wi-Fi.
3. The Solarbank 2 E1600 Pro/Plus and the smart meter should be as close to the router as possible, within a distance of no more than 10 meters, with minimal obstacles in between. Avoid placing them behind walls to ensure a stable Wi-Fi signal, or consider adding a repeater to enhance the signal.
4. The distribution box may affect signal transmission. Check whether the external antenna of the smart meter has been installed and placed outside the distribution box.
5. Delete the Solarbank and the smart meter in the Anker app, then re-add them to see if they can communicate normally.
6. Check whether the router has any special settings that might affect communication.
7. Connect to a mobile hotspot or switch to a router of a different brand to see if the communication is normal.

If the above steps still cannot solve the problem, please upload the logs and provide the SN of both the Solarbank 2 E1600 Pro/Plus and the smart meter.

If you have any questions, feel free to contact Anker Customer Support for further assistance.

Q28: What should I do if the app shows error code 35: incorrect electric meter connection?

Please follow the instructions to check and correctly connect the meter CT, and ensure the network is good. Please check the following:

1. The measurement position of the meter CT is on the incoming line side of the household, not on the load branch.
2. There is an arrow on the CT of the smart meter. The direction of the arrow should point towards the external power grid, which is the source of the external current.
3. Make sure the meter's voltage sampling and current sampling are in the same phase. After the wiring is corrected, the alarm will disappear once the system test passes (about 5 minutes).

Q29: Why can't connect to the Bluetooth of the Solarbank 2 E1600 Pro/Plus?

If the Solarbank 2 E1600 Pro/Plus cannot connect via Bluetooth, the possible reasons are:

1. The device did not respond to the APP command, resulting in communication timeout and the APP disconnecting Bluetooth.
2. Mobile phone compatibility issues, some mobile phones will be disconnected during the Bluetooth connection process.
3. Environmental interference, Bluetooth can be searched, but disconnected during the connection process.
4. Bluetooth is turned off abnormally.

You can try the following steps:

1. Reinitiate Bluetooth broadcast: Press and hold the IOT button for more than 7 seconds to search and connect the device again.
2. Restart the mobile APP: Close and reopen the APP on the mobilephone, and try to connect to the device again.
3. Restart the device: power off and then on, restart the device and try to connect again.
4. Try using another mobile phone to connect the device to determine whether it is a mobile phone compatibility issue.

If you still cannot connect successfully, please upload the APP log, device log and device SN for further analysis and problem solving.

If you have any questions, feel free to contact Anker Customer Support for further assistance.

Q30: What should I do if my Solarbank 2 Pro/Plus cannot connect to my home router's Wi-Fi?

Possible reason: Weak signal or router setting issues

Suggestion: Please try the following steps:

1. Ensure that you have entered the correct SSID and password, paying attention to special characters such as spaces, underscores, and hyphens.
2. Adjust the position of the device, keeping it within 10 meters of the router with minimal obstructions in between. Avoid placing it behind walls to ensure a stable Wi-Fi signal, or consider adding a repeater to strengthen the signal.
3. Confirm that the router and the Solarbank E1600 Pro/Plus are using 2.4GHz communication, as the Solarbank E1600 Pro/Plus does not support 5GHz Wi-Fi.
4. Check whether WiFi-connected devices have reached the upper limit that can be supported, and turn off some devices.
5. Confirm that the security encryption protocol of the router is set to WPA2 or above.
6. Power off the device and restart it. You can first use your mobile phone to establish a Bluetooth connection with Solarbank E1600 Pro/Plus, and then reset Wi-Fi.

If the above steps fail to resolve the issue, you can temporarily use your mobile phone as a hotspot instead of the router WiFi. If the Solarbank 2 E1600 Pro/Plus network is stable in this case, the problem is more likely to be with the router.

Specifications

Specifications are subject to change without notice.

Model		A17C2
PV Terminal	Max PV Input Voltage	60Vd.c.
	Max PV Input Current	16Ad.c. / 16Ad.c.
	Max Isc PV	20Ad.c. / 20Ad.c.
	Max PV Input Power	600W / 600W
	Operation Voltage Range	16-60Vd.c.
Battery Terminal	Battery Name	Rechargeable Li-ion Battery
	Battery Nominal Voltage	16Vd.c.
	Max Charge Current	70Ad.c.
	Max Discharge Current	75Ad.c.
	Rated Power (Single Device)	1000W
	Rated Energy (Capacity)	1600Wh
	Rated Capacity	100Ah
	IEC Code	IFpP51/161/120[5S]M/-20+50/90
General Parameters	Enclosure	Class I
	Ingress Protection	IP65
	Inverter Topology (Solar)	Isolated
	Inverter Topology (Battery)	HF
AC Input (On-grid terminal)	Max. AC Input Power	2000W
	Max. AC Input Apparent Power	2000VA
	Max. AC Input Current	10Aa.c.
	AC Rated Input Voltage	L+N+⏏, 220Va.c./230Va.c., 50Hz
AC Output (On-grid terminal)	AC Output Power	800W
	AC Rated Output Voltage	L+N+⏏, 220Va.c./230Va.c., 50Hz
	Max. AC Output Current	3.5Aa.c.
	Power Factor	0.8 lagging-0.8 leading
AC Input and Output (Off-grid terminal)	Max. AC Input and Output Power	2000W
	Max. AC Input and Output Apparent Power	2000VA
	Max. AC Input and Output Current	10Aa.c.
	AC Rated Input and Output Voltage	L+N+⏏, 220Va.c./230Va.c., 50Hz
	Power Factor	0.8 lagging-0.8 leading
Temperature	Charging Temperature Range	-20°C~55°C
	Discharging Temperature Range	-20°C~55°C
	Heating Film	-20°C~0°C
Disclaim	<p>In grid-connected mode, the off-grid port can support a 2000W load.</p> <p>In off-grid mode, by clicking the off grid bottom, a single off-grid port can support a 1000W load.</p> <p>In off-grid mode, by clicking the off grid bottom, a single off-grid port with a battery pack can support a maximum load of 1200W.</p> <p>The microinverter limit is 800W maximum. German regulations limit balcony photovoltaic systems to 800W, so we recommend using a compliant microinverter. If your microinverter power exceeds 800W, please lower it to at most 800W.</p>	